

XIUM

Construction Manual



IG KOGYO

1.	Handling Precautions	1
2.	Parts List	2
3.	Range of Use	3
4.	Tools & Materials Req. for Construction	4~5
5.	Construction Process	
5-1.	Construction for Horizontal Siding	
	—— Marking	6
	—— Sub-System A Installation	7
	—— Sub-System B Installation	8
	—— Frame Installation【Bottom, Left, Right】	9
	—— Xium Installation ①	10
	—— Xium Installation ②	11
	—— Frame Installation【Upper】	12
	—— Completion	13
	—— Sectional View	14
5-2.	Construction for Vertical Siding	
	—— Marking	15
	—— Sub-System A Installation	16
	—— Sub-System B Installation	17
	—— Frame Installation【Bottom, Left, Right】	18
	—— Xium Installation ①	19
	—— Xium Installation ②	20
	—— Frame Installation【Right】	21
	—— Completion	22
	—— Sectional View	23
5-3.	Construction for Reinforced Concrete Wall	
	—— Marking	24
	—— Sub-System A Installation	25
6.	Sub-System Cutting	
	—— Cutting Layout Example	26
	—— Marking	27
	—— Sub-System A Cutting	28
	—— Sub-System B Cutting	29
7.	Maintenance / Cleaning	30

Xium is a wall material. Do not use on anything other than walls.



Warning: This mark is displayed to note risk of death or serious injury.

1. Do not work from high locations during strong winds, rainy weather, or snowfall. These conditions may lead to a fall-related accident.
2. When working from high locations, please follow all relevant regulations, and understand that the possibility of an accident exists.
3. Direct contact with wiring may cause electric shock. Take caution when near electrical wiring to avoid electric shock.



Caution: This mark is displayed to note risk of injury or property damage if the product is not handled properly.

■ Design Precautions

- Install onto site without cutting the Xium body.
- When installing Frame (Titanium) or Frame (Aluminum), install onto site with sufficient space for screws.
- Do not install onto slanted parapet or curved wall.
- Do not use in any direction other than specified tensile direction.
- Do not use in areas constantly exposed to water and steam, such as hot springs, bathrooms, etc.
- Do not use in areas constantly exposed to high temperatures, such as chimneys and fireplaces, etc. Such environments may cause deformation, warping, and reduced durability.
- When moving forward with a design, make sure to be in compliance with all building standards, as well as any related laws and regulations.

■ Construction Precautions



- Please wear gloves and handle Xium with care, as its surface may be easily scratched or dirtied.
- Wear clean gloves when constructing with Xium. Touching the surface with bare hands will leave fingerprints, hand marks, and other impurities. If fingerprints are applied, wipe them off as soon as possible. (See p30)
- Install Xium with protective film still attached. Remove protective film after the completion of Xium installation.

■ Work Safety Precautions

- Wear appropriate protective equipment during the handling process, such as rubber gloves and safety glasses, etc. There is a risk of injury.
- Remove any burrs from cut surfaces during on-site processing. There is a risk of injury.
- Take sufficient care during the curing process, as any welding flames or sparks, etc., may cause a fire or damage to the product.
- Take caution during periods of strong summer sunlight, as plate surface temperatures rise and carry the risk of causing burns.

■ Storage Precautions

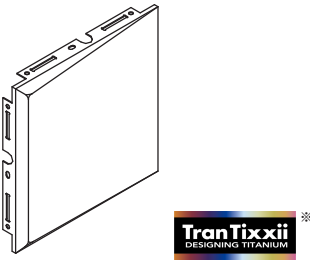
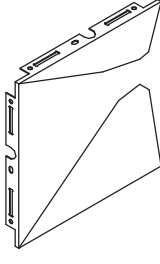
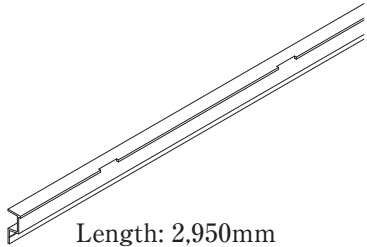
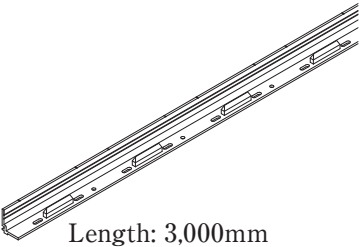
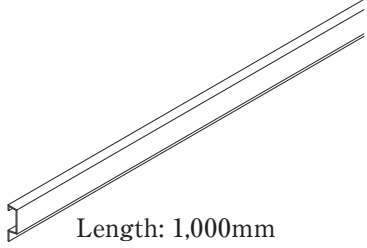
- Keep Xium in a place where it will not get wet.
- Store along dust-free flooring, and do not leave it outdoors.
- Avoid storing near windows or doorways as much as possible. Condensation may form on the product's surface due to sudden changes in outside temperatures.
- A protective film is attached to Xium. Please store indoors and out of direct sunlight, and install as soon as possible. Long-term storage will deteriorate the protective film, which can cause it to become difficult to peel off, as well as leave behind glue residue.

Product Name	Xium-TITAN		Xium-ALUMI
Product Diagram			
Design Price	5,370yen / Sheet		4,610yen / Sheet
Material	Titanium		Aluminum
Product Code	TIT1-000		ALU1-000
Pack Units	25 / Box		25 / Box
Product Name	Sub-System A		Sub-System B
Product Diagram			
Design Price	3,580yen / Unit		7,160yen / Unit
Material	Aluminum		Aluminum
Product Code	STX1-000		STX2-000
Pack Units	10 / Box		10 / Box
Product Name	Frame (Titanium)	Frame (Aluminum)	Xium Screw 4x13
Product Diagram			
Design Price	4,850yen / Unit	3,530yen / Unit	2,930yen / Unit
Material	Titanium	Aluminum	Stainless Steel (highly corrosion resistant finish)
Product Code	TIT2-000	ALU2-000	STX3-000
Pack Units	5 / Box	5 / Box	100 / Bag

※Xium-TITAN uses Nippon Steel Corporation's TranTixxii designing titanium.

■ Construction Conditions

● External Wall Conditions

- Xium can be installed on the following external walls:
Metal Siding (SF-GALBRIGHT JF, SF-GALSTAGE SHINE J, SF-GALSPAN J, GALSPAN SEi Fluorine)
Reinforced Concrete Wall

● Construction Part Conditions

- Construction for flat surfaces, including metal siding horizontal and vertical joints
- Construction for Reinforced Concrete Wall flat surfaces
- Construction for parts that can be attached without cutting the Xium body
- Construction for parts where space can be made available for screws when installing Frame (Titanium) or Frame (Aluminum)

● Minimum Installation Conditions

When installing on metal siding

- Possible to install two or more rows of Sub-System A on furring material that holds siding

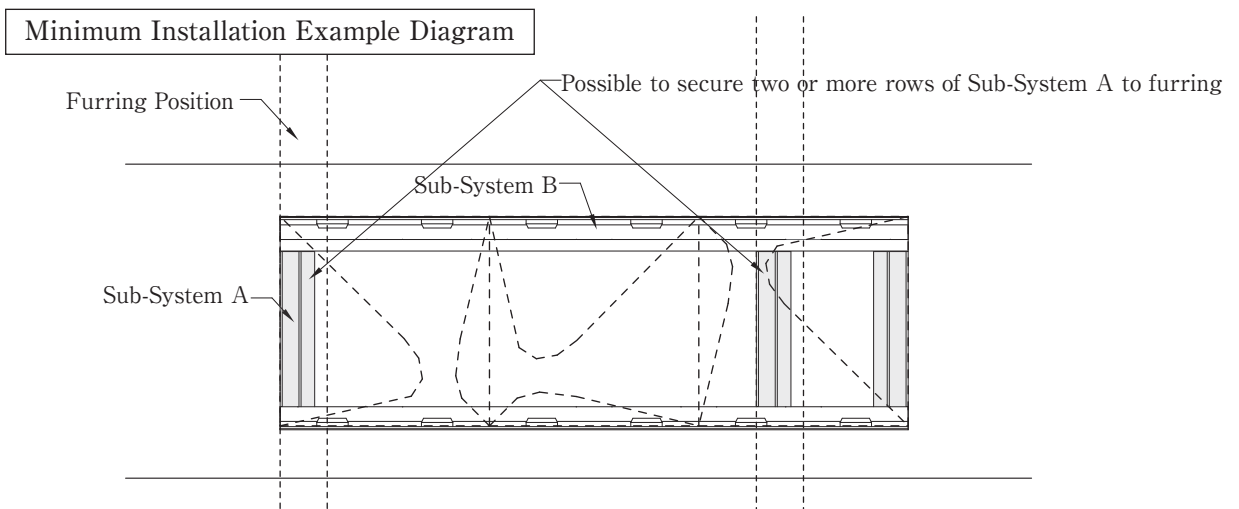

When installing on Reinforced Concrete Wall

- Can be installed with one Xium



■ Certifications

- Certified Noncombustible Material

Product Name	Certification Number
Xium-TITAN, Frame (Titanium)	NM8596 (Japan Titanium Society Certified)
Xium-ALUMI, Frame (Aluminum), Sub-System A, Sub-System B	Certification expected in late Jun, 2020

- For certification compatibility, such as those related to fireproofing of structures on which Xium has been installed on our siding, please check with the architect or designated inspection agency.

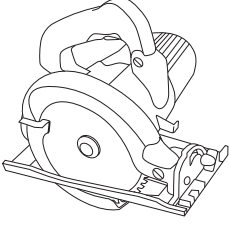
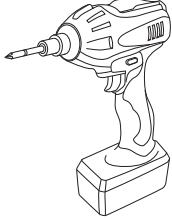
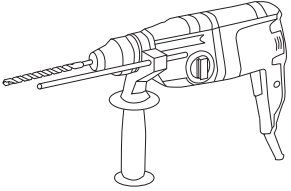
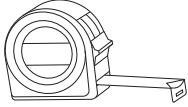
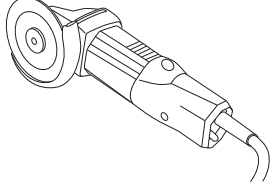
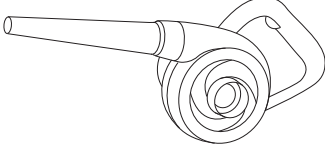
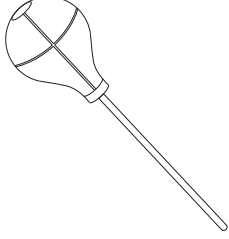
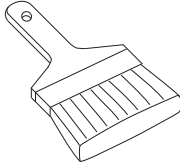
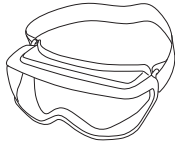
■ Tools Req. For Construction

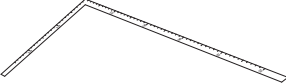
Electric Circular Saw	Impact Driver	Lightweight Hammer Drill
		
Tape Measure	Sander	Blower
		
Dust Blower	Brush	Safety Glasses
		
Level	Carpenter's Square	
		

■Fastening

<When constructing external wall metal siding>

Mounting	Application	Type	Length (fastening)
Sub-System A	Penetrate siding with Sub-System A, and secure to furring	Stainless Steel Pan Head Course Thread (commercial item)	Length that can be fastened to Sub-System A + siding + furring thickness
	Secure Sub-System A to siding surface steel plate	Stainless Steel Sheet Screw (commercial item)	Length that can be fastened to Sub-System A + siding surface steel plate thickness, without penetrating siding

<When constructing on reinforced concrete external wall>

Mounting	Application	Type
Sub-System A	Secure Sub-System A to Reinforced Concrete Wall	Stainless Steel Screw for Reinforced Concrete (commercial item)

Reinforced Concrete Screw Installation Precautions

- For Reinforced Concrete Wall pilot holes, please follow all diameter and depth guidelines set by the screw manufacturer. Pilot holes made larger than the set diameter will provide decreased retention.
- After drilling a pilot hole in the Reinforced Concrete Wall, remove any chips or shavings from the hole.
- Note that over-tightening will reduce retention.
- When working with a mortar finish, or adjusting unevenness, select a screw that takes the related thickness into consideration.

<External Wall Commonalities>

Mounting	Application	Type
Sub-System B	Secure Sub-System B to Sub-System A	Xium Screw 4x13 (our official product)
Xium-TITAN, Xium-ALUMI	Secure Xium to Sub-System B	
Frame (Titanium) Frame (Aluminum)	Secure Frame (Titanium) or Frame (Aluminum) to Sub-System A	

Marking

- Mark the Xium installation perimeter and furring position.

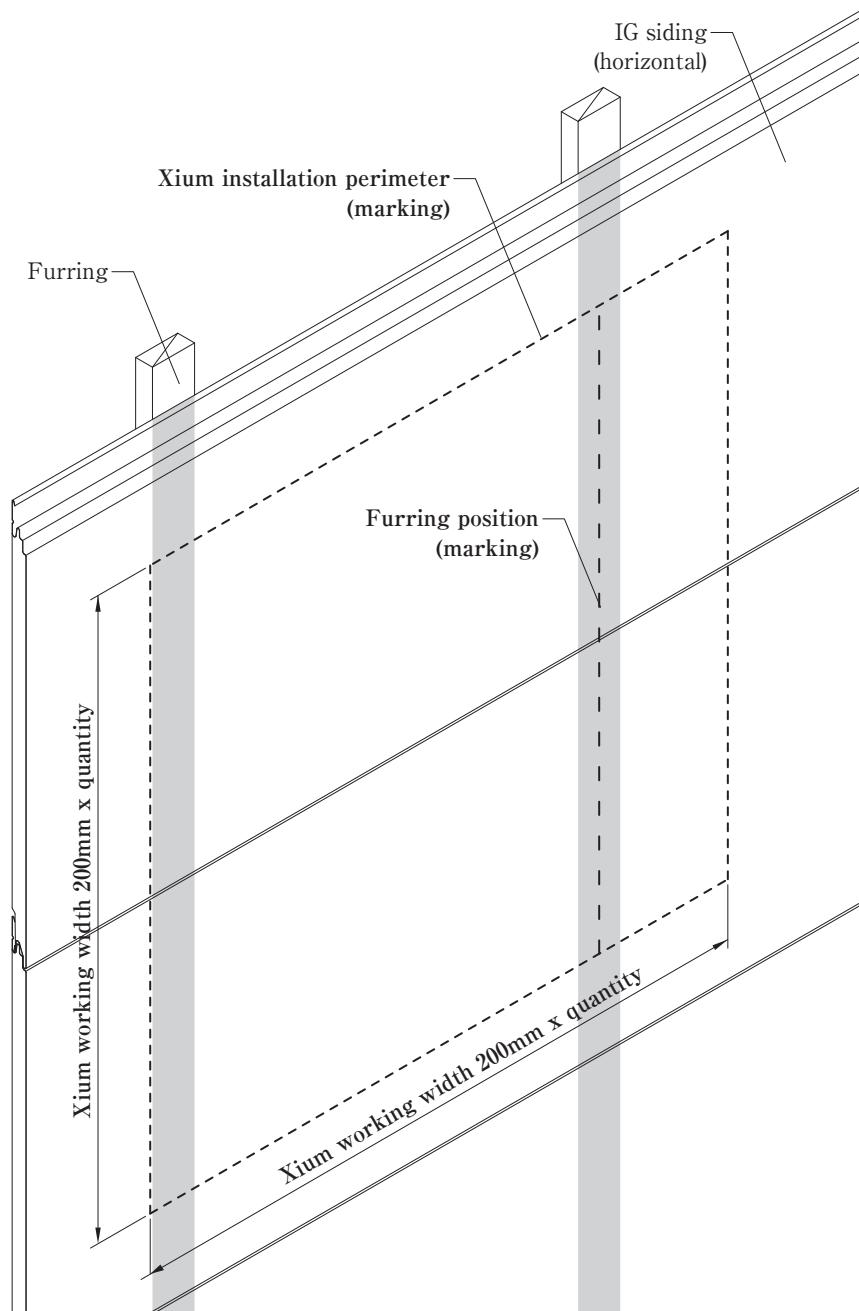

Sub-System A Installation

- Align the sides of Sub-System A with the Xium installation perimeter when installing.
- Between the upper and lower Sub-System A, install Sub-System A vertically along the furring, as shown below.
- For fastening Sub-System A, use stainless steel course thread at furring positions, and where there is no furring, use stainless steel sheet screw, and attach Sub-System A after drilling pilot holes.
- When attaching Sub-System A to SF-GALSPAN J (attaching to recess), secure in place after inserting a commercially available spacer into the recess.

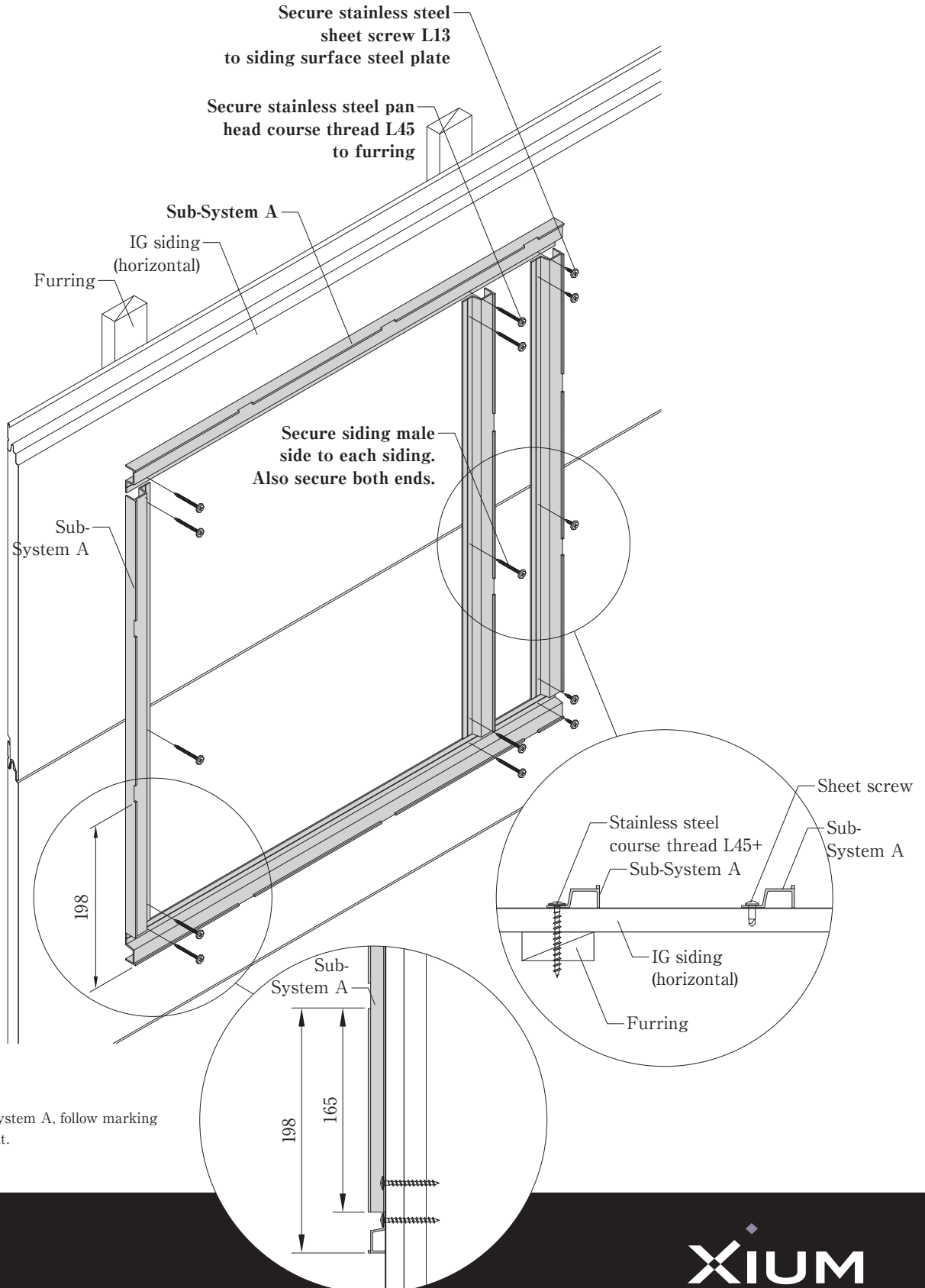

Caution: When installing Sub-System A, follow marking line so as not to twist it.

Sub-System B Installation

- For lower and upper ends, Sub-System B is combined with Sub-System A as shown below.
- For the general portion, insert Sub-System B into the notch on Sub-System A.

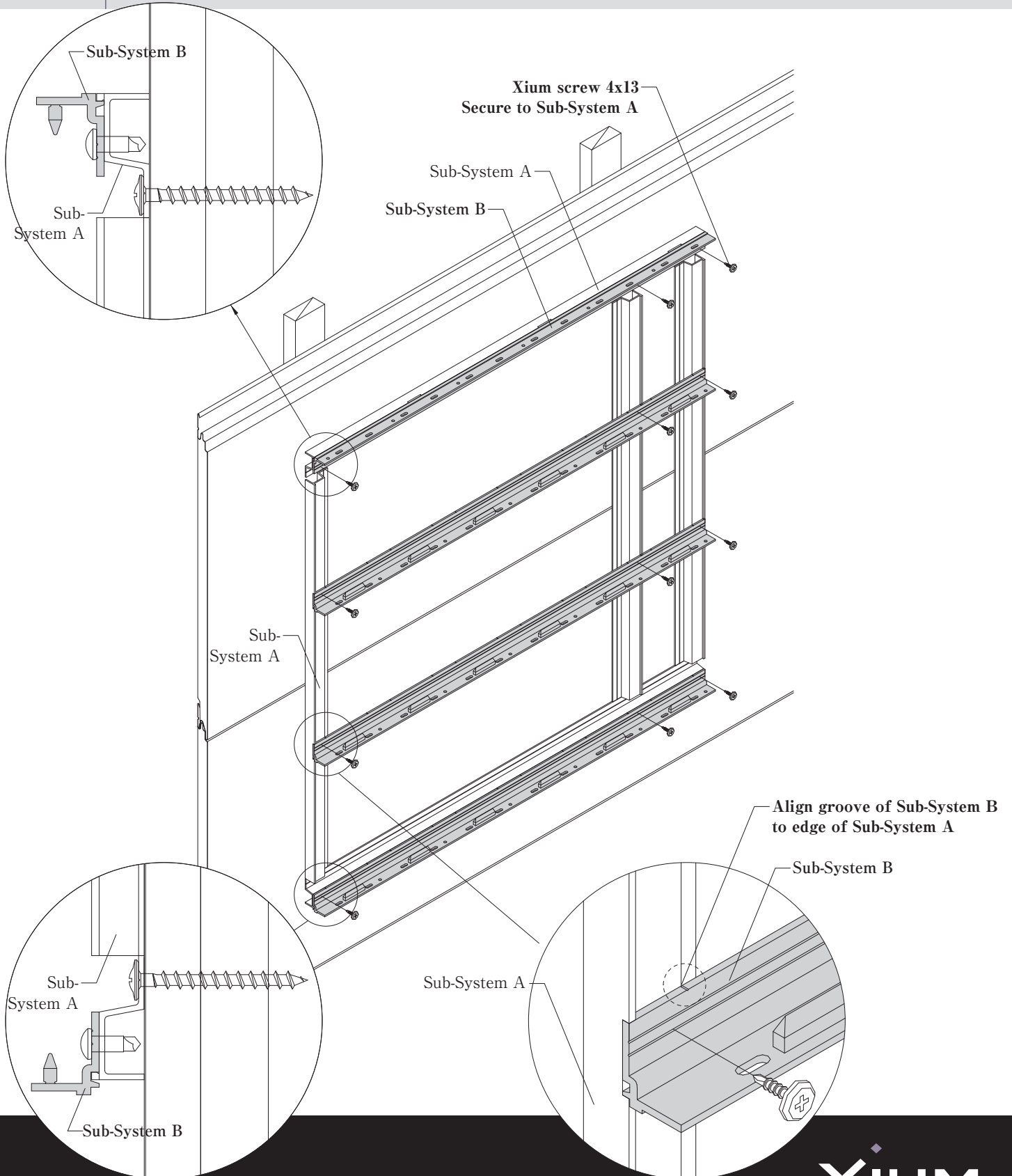

Frame Installation [Bottom, Left, Right]

• Secure Frame to bottom, left, and right Sub-System A with Xium screw 4x13. If Frame cannot be secured from the side, secure Sub-System A after securing Frame to Sub-System A.

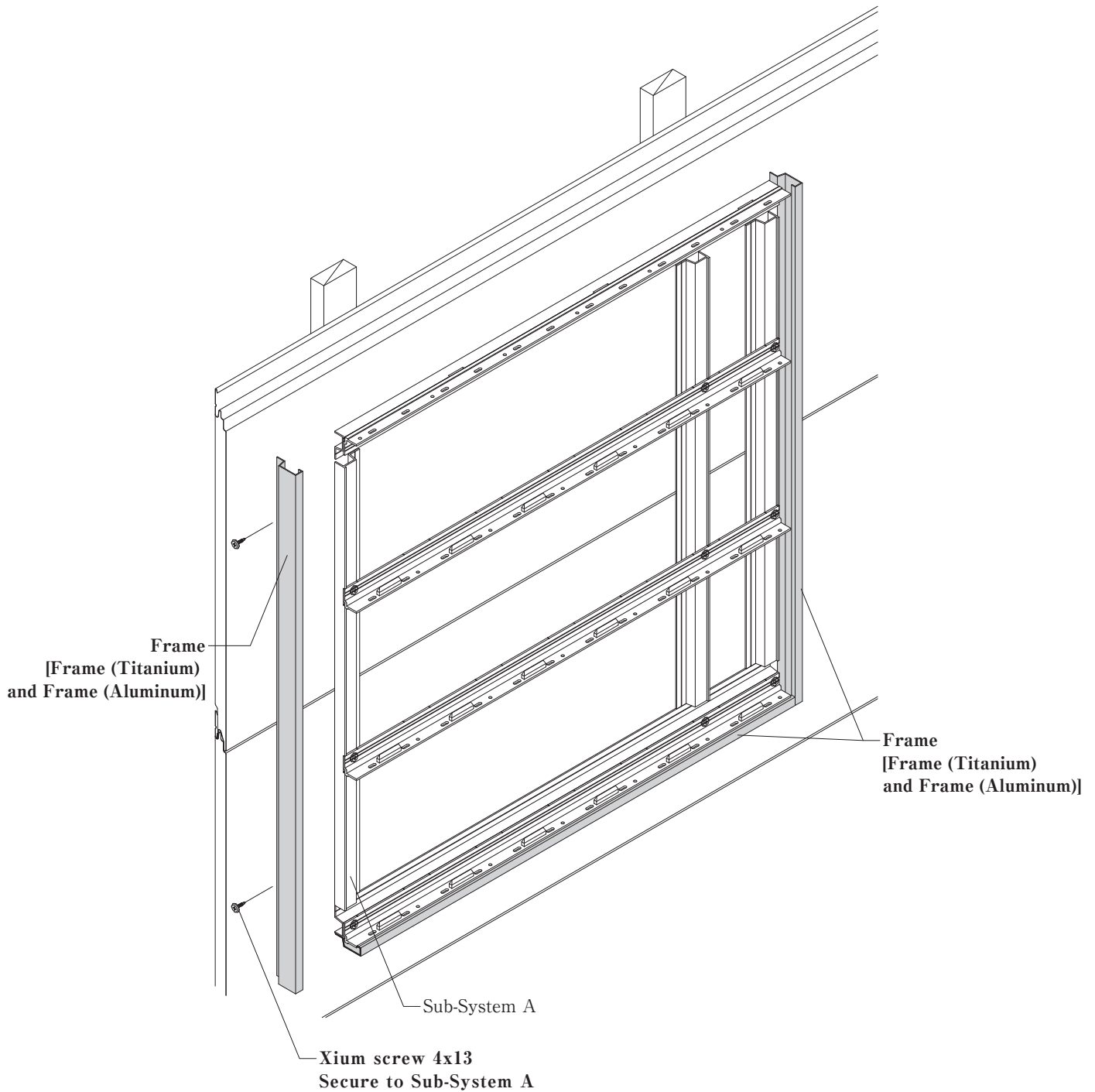

Xium Installation ①

·Inset Xium holes into Sub-System B protrusions, secure Xium top middle holes one at a time with Xium screw 4x13. Xium in the left column is positioned against the edge of the Frame. The next Xium matches the left Xium. Install while checking for vertical misalignment every few columns. Adjust the positions of the right side Sub-System A and Frame in accordance with the position of the Xium in the last column.

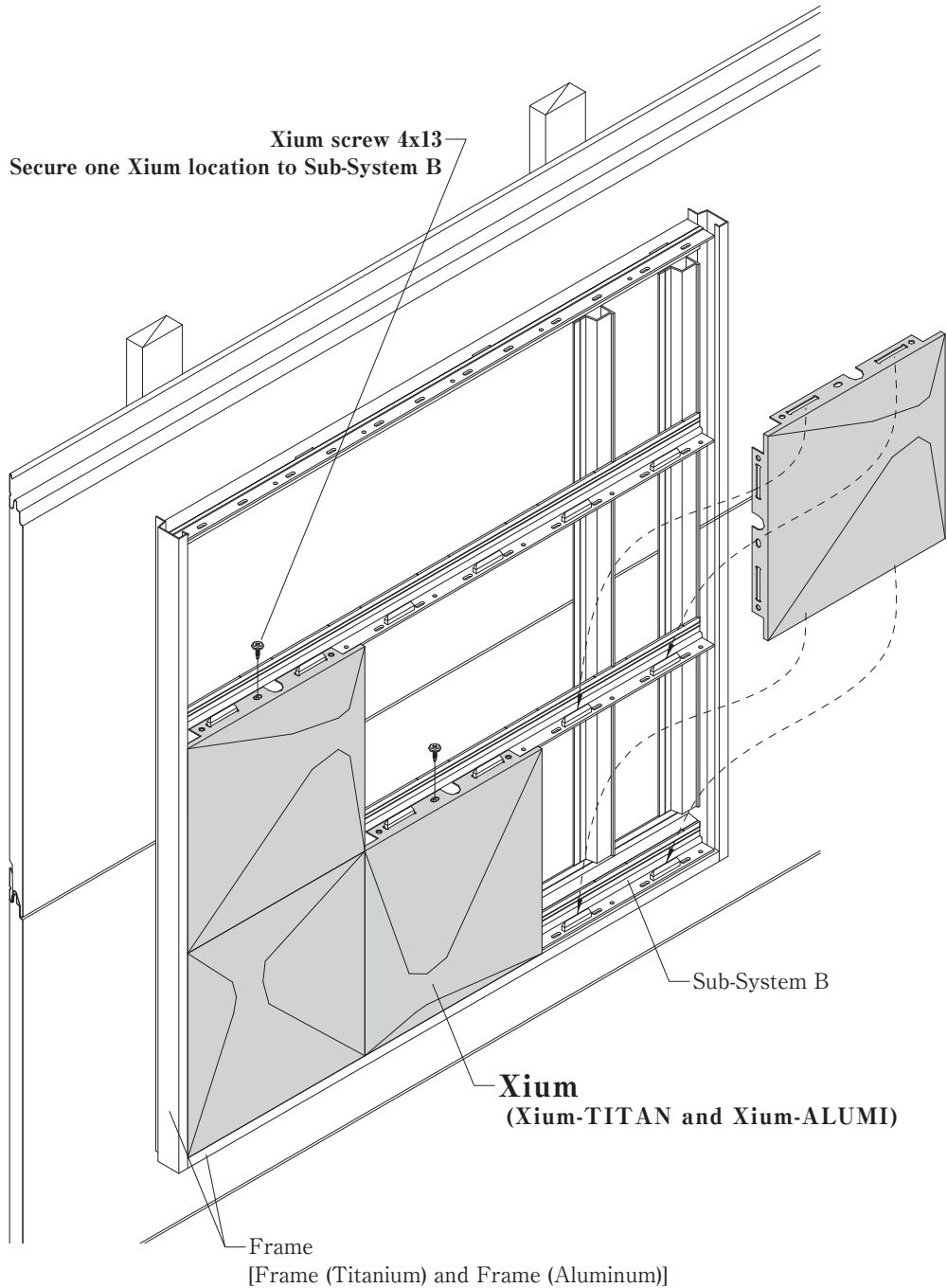

Caution: Install Xium with protective film still attached. Do not install with bare hands. Remove protective film immediately after the completion of Xium installation.

Xium Installation ②

·For upper portion, inset Xium holes into bottom Sub-System B protrusions only, secure in upper left and right holes with Xium screw 4x13.

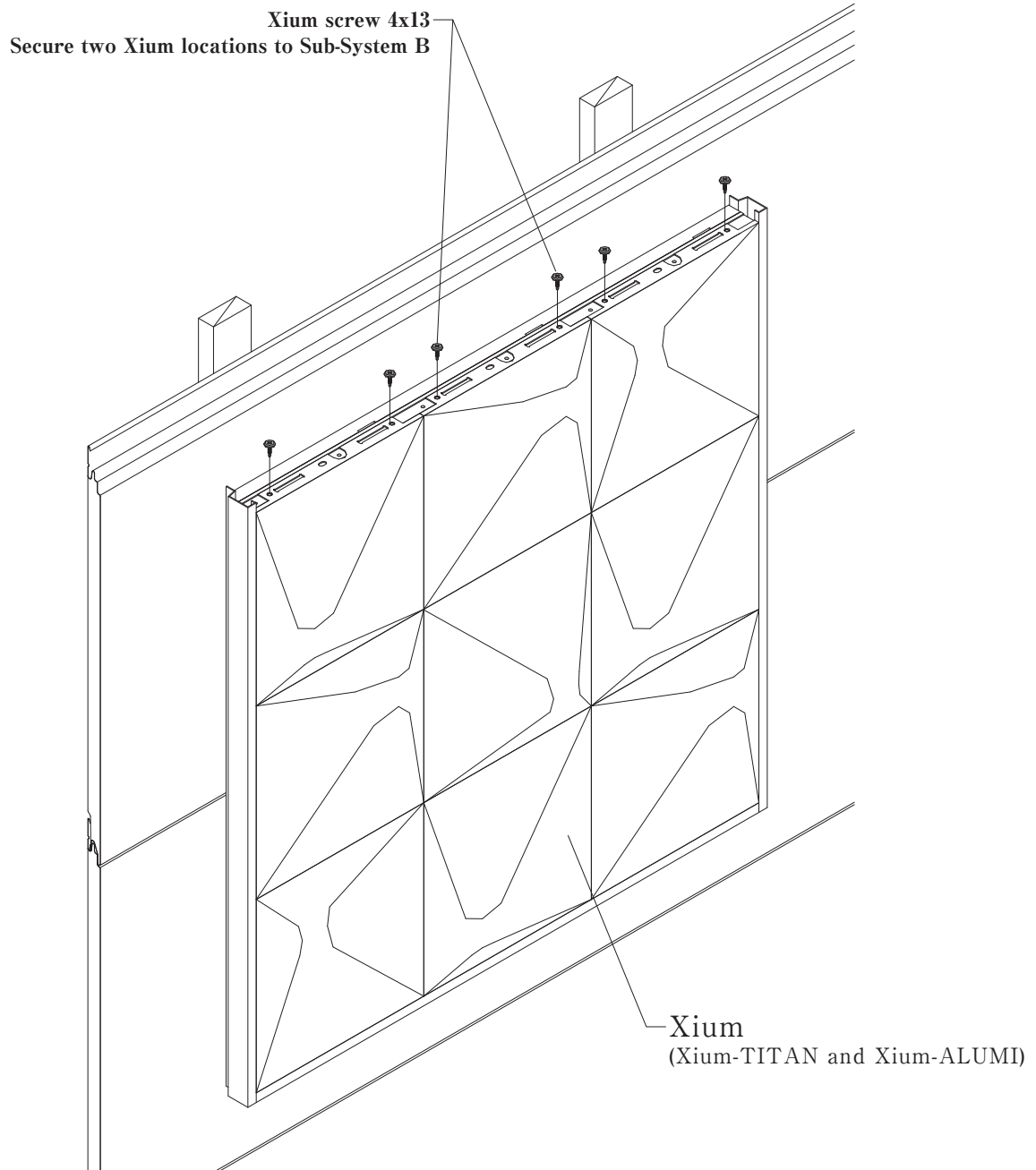

Caution: Install Xium with protective film still attached. Do not install with bare hands. Remove protective film immediately after the completion of Xium installation.

Frame Installation 【Top】

- Secure Frame to top Sub-System A with Xium screw 4x13.

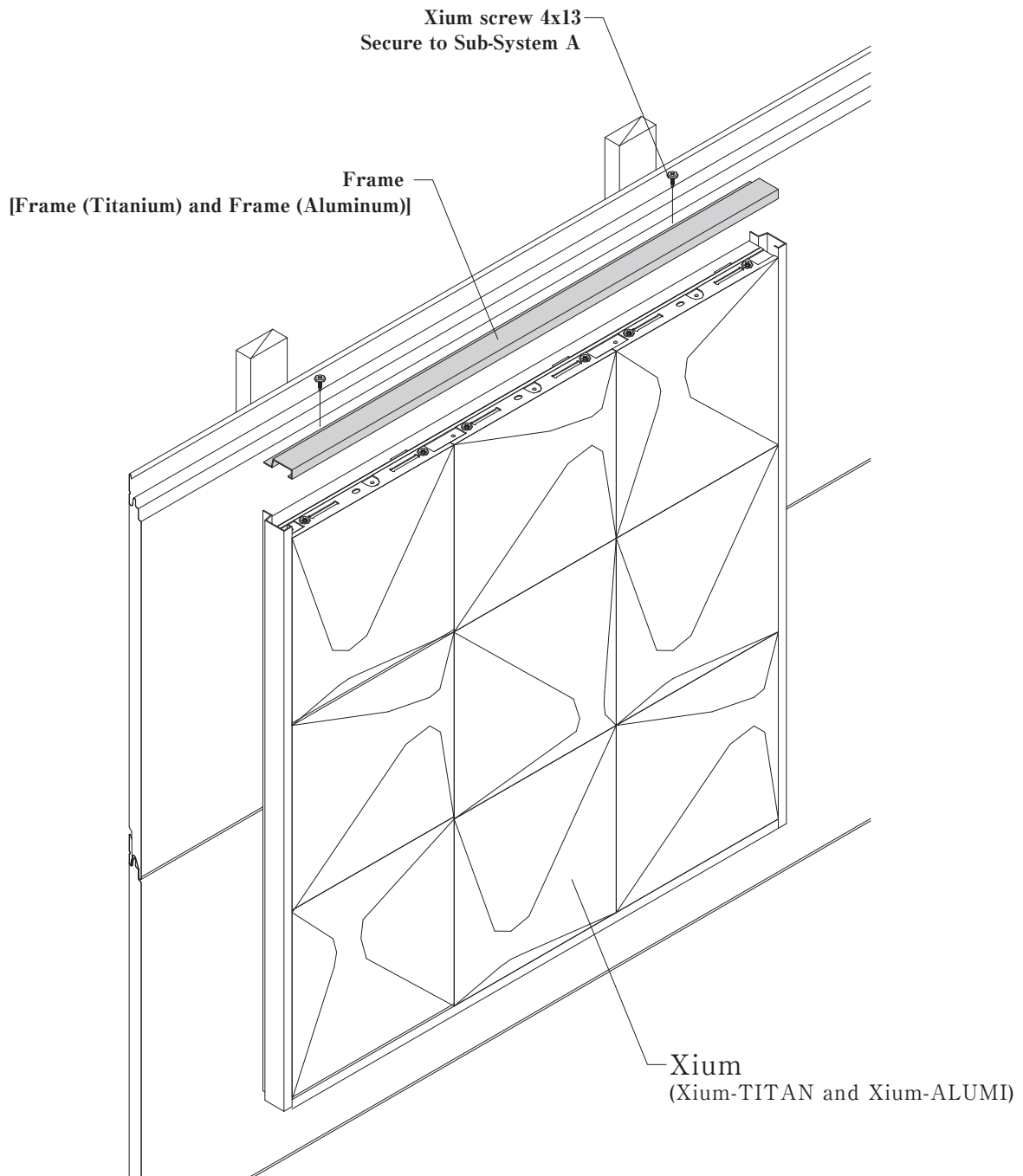

Caution: Install Xium with protective film still attached. Do not install with bare hands. Remove protective film immediately after the completion of Xium installation.

Completion

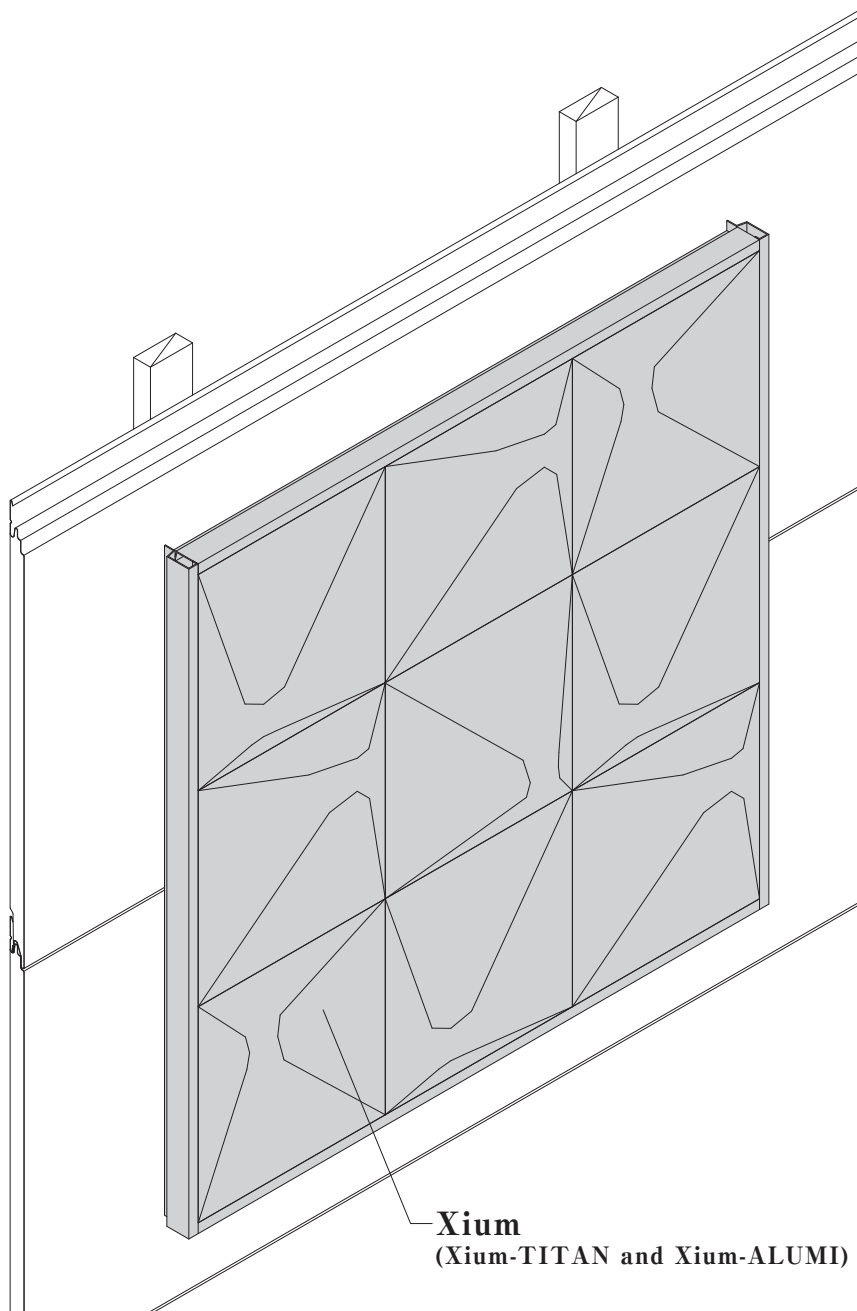

Caution: Install Xium with protective film still attached. Do not install with bare hands. Remove protective film immediately after the completion of Xium installation.

Sectional View

Horizontal Cross Section

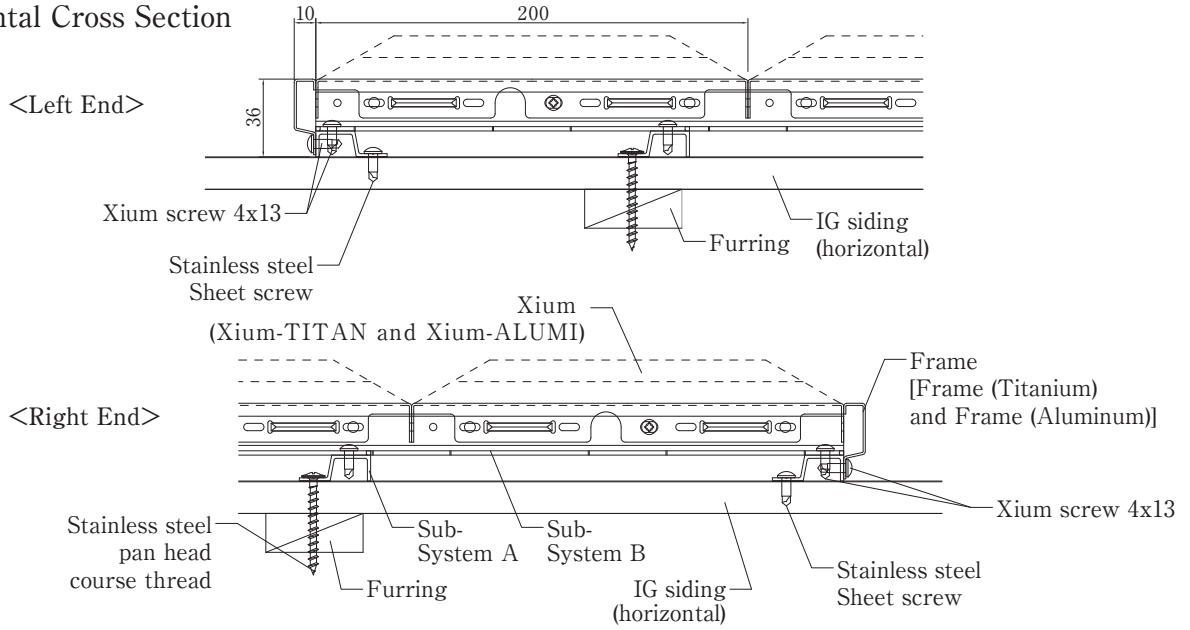

Vertical Cross Section

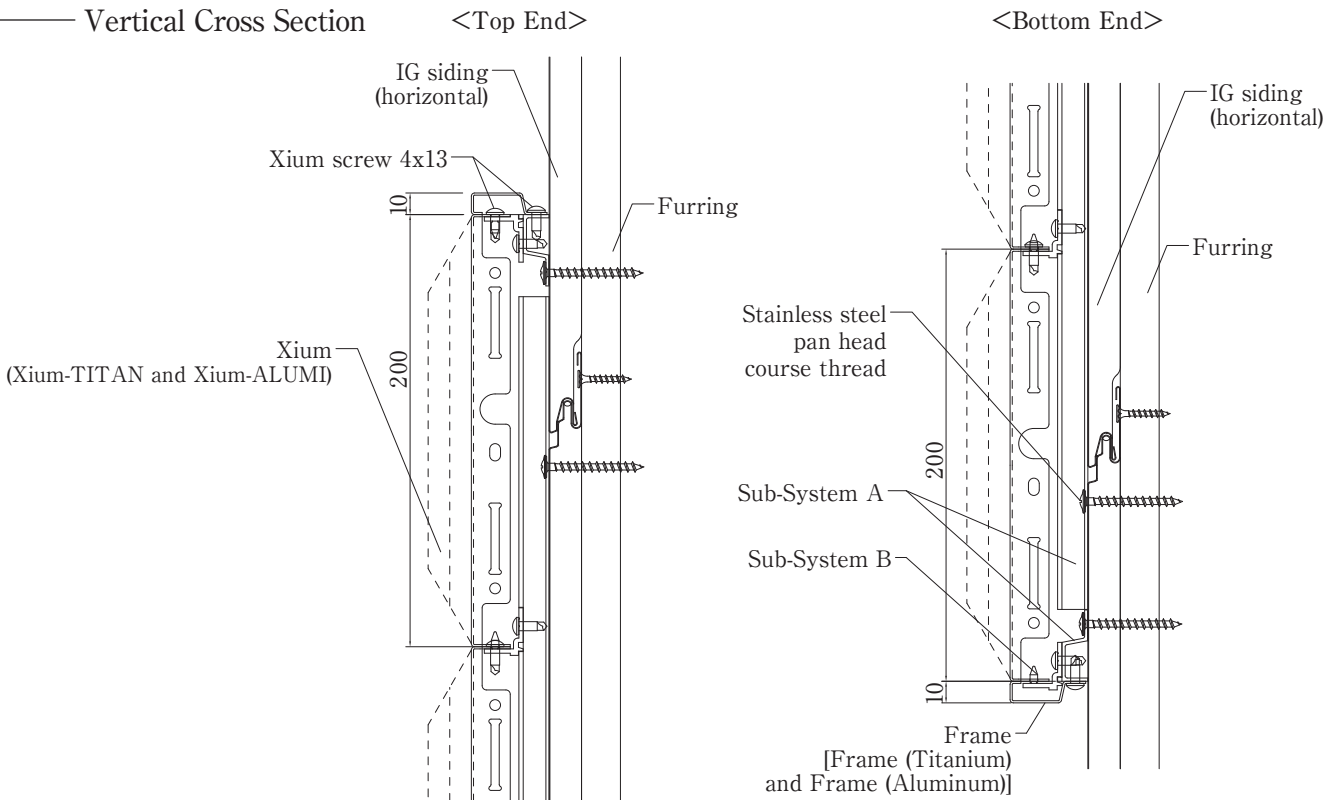

Marking

- Mark the Xium installation perimeter and furring position.

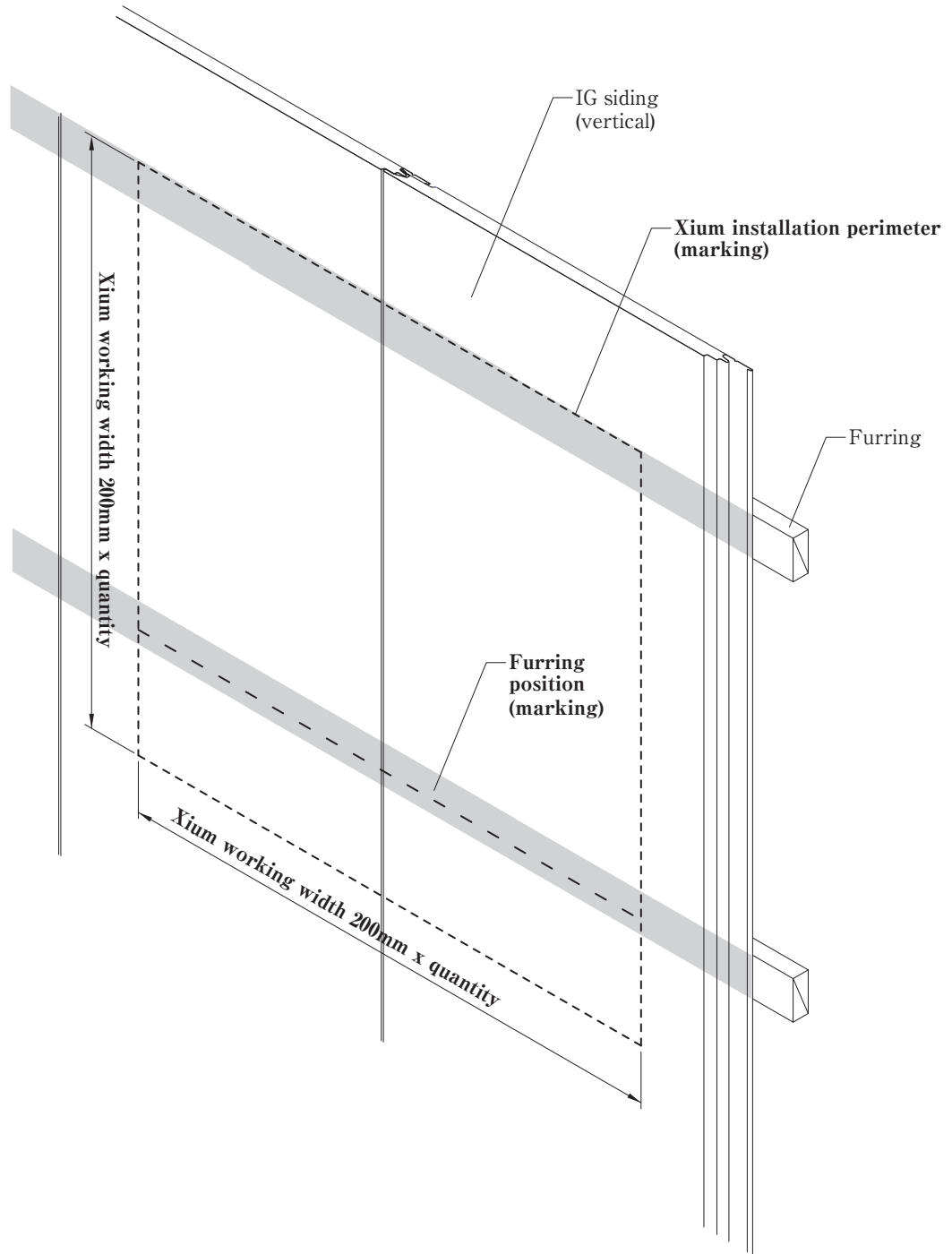

Sub-System A Installation

- Align the sides of Sub-System A with the Xium installation perimeter when installing.
- Between the left and right Sub-System A, install Sub-System A horizontally along the furring, as shown below.
- For fastening Sub-System A, use stainless steel course thread at furring positions, and where there is no furring, use stainless steel sheet screw, and attach Sub-System A after drilling pilot holes.
- When attaching Sub-System A to SF-GALSPAN J or GALSPAN SEi Fluorine (attaching to recess), secure in place after inserting a commercially available spacer into the recess.

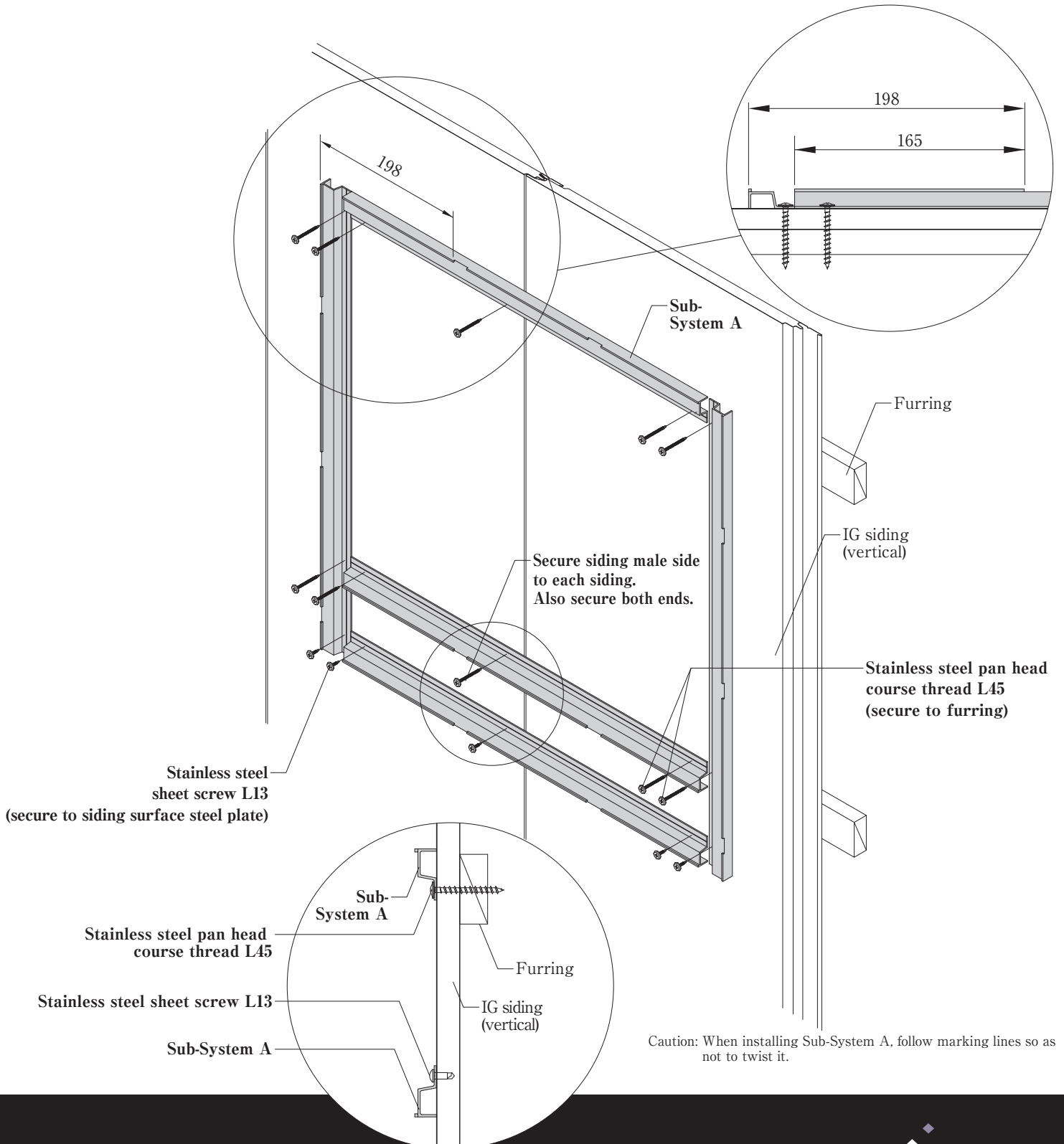

Sub-System B Installation

- For left and right ends, Sub-System B is combined with Sub-System A as shown below.
- For the general portion, insert Sub-System B into the notch on Sub-System A.

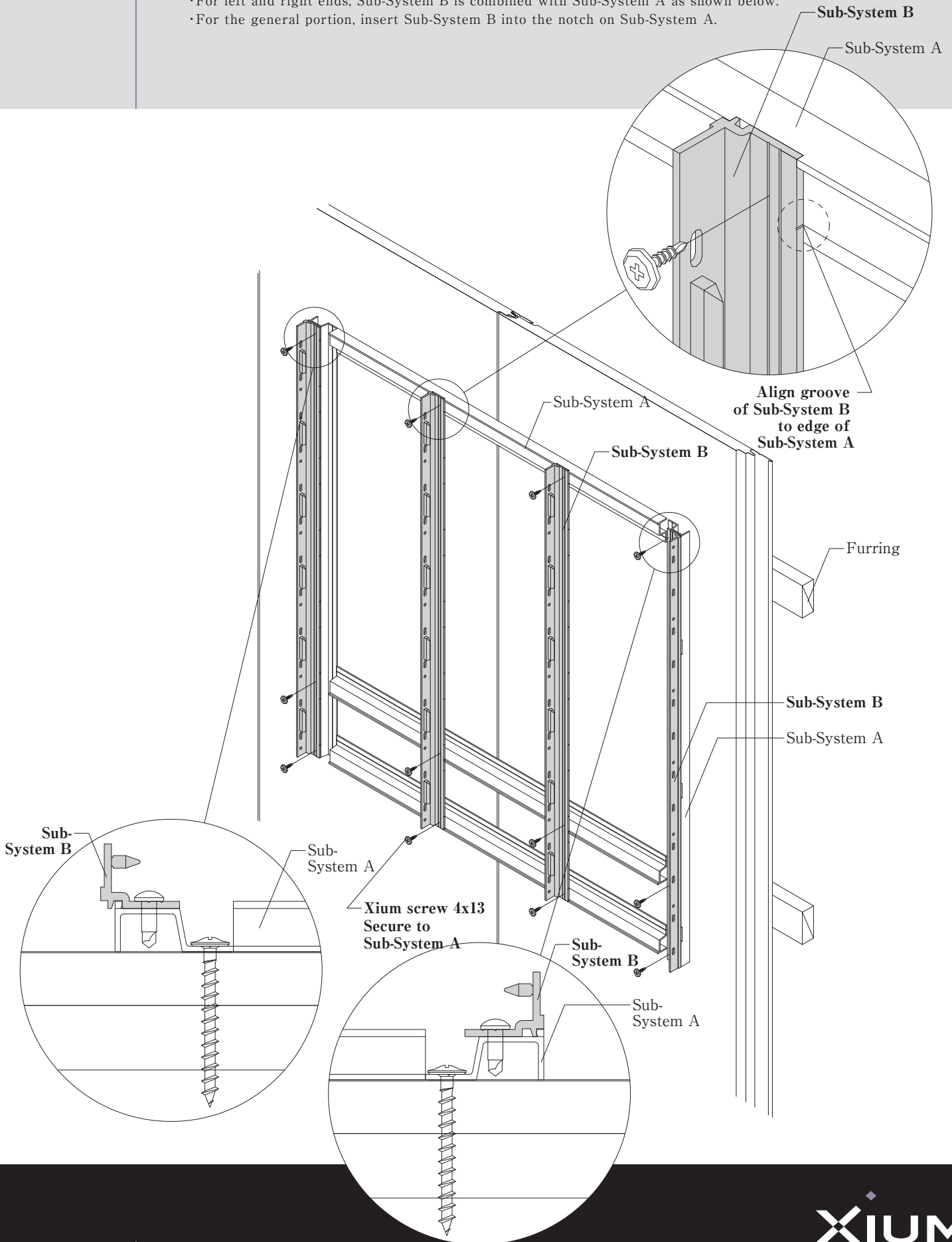

Frame Installation [Bottom, Top, Left]

- Secure Frame to top, bottom, and left Sub-System A with Xium screw 4x13.
- If Frame cannot be secured from the side, secure Sub-System A after securing Frame to Sub-System A.

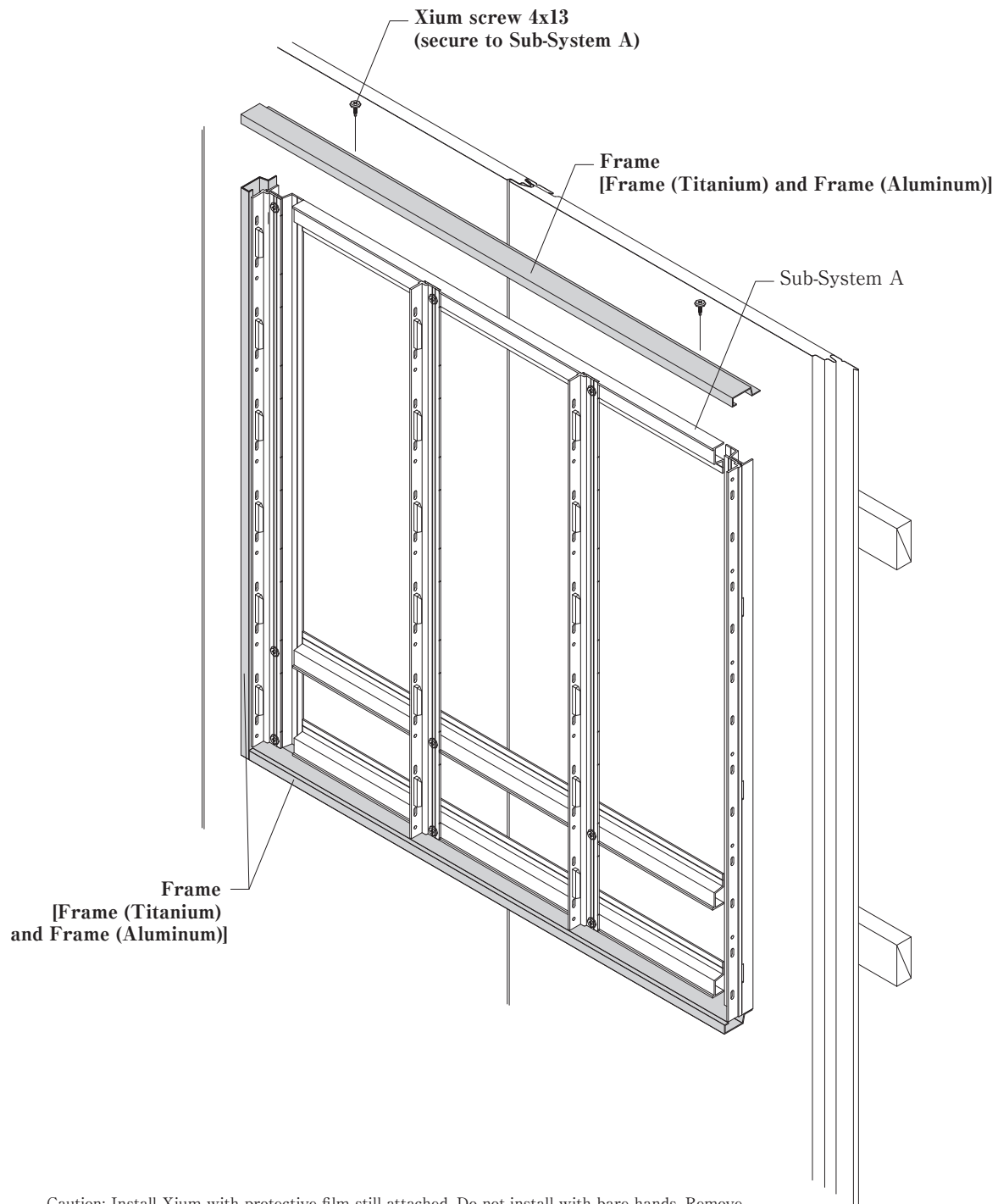

Caution: Install Xium with protective film still attached. Do not install with bare hands. Remove protective film immediately after the completion of Xium installation.

Xium Installation ①

- Inset Xium holes into Sub-System B protrusions, secure Xium right middle holes one at a time with Xium screw 4x13. Xium in the lower row is positioned against the edge of the Frame.
- The next Xium matches the lower Xium. Install while checking for horizontal misalignment every few rows.
- Adjust the positions of the right side Sub-System A and Frame in accordance with the position of the Xium in the last row.

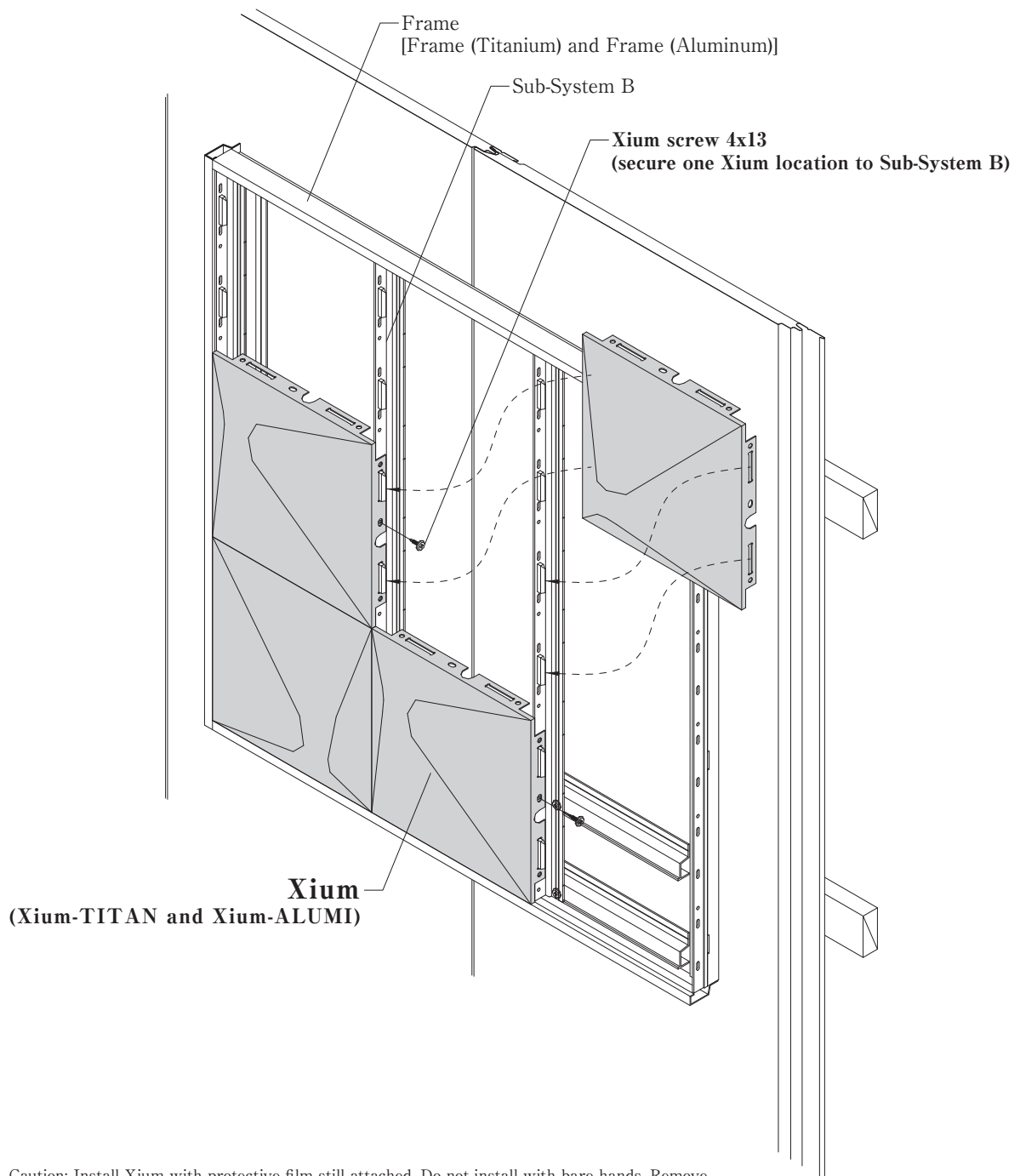

Caution: Install Xium with protective film still attached. Do not install with bare hands. Remove protective film immediately after the completion of Xium installation.

Xium Installation ②

- For right portion, inset Xium holes into left Sub-System B protrusions only, secure in right upper and lower holes with Xium screw 4x13.

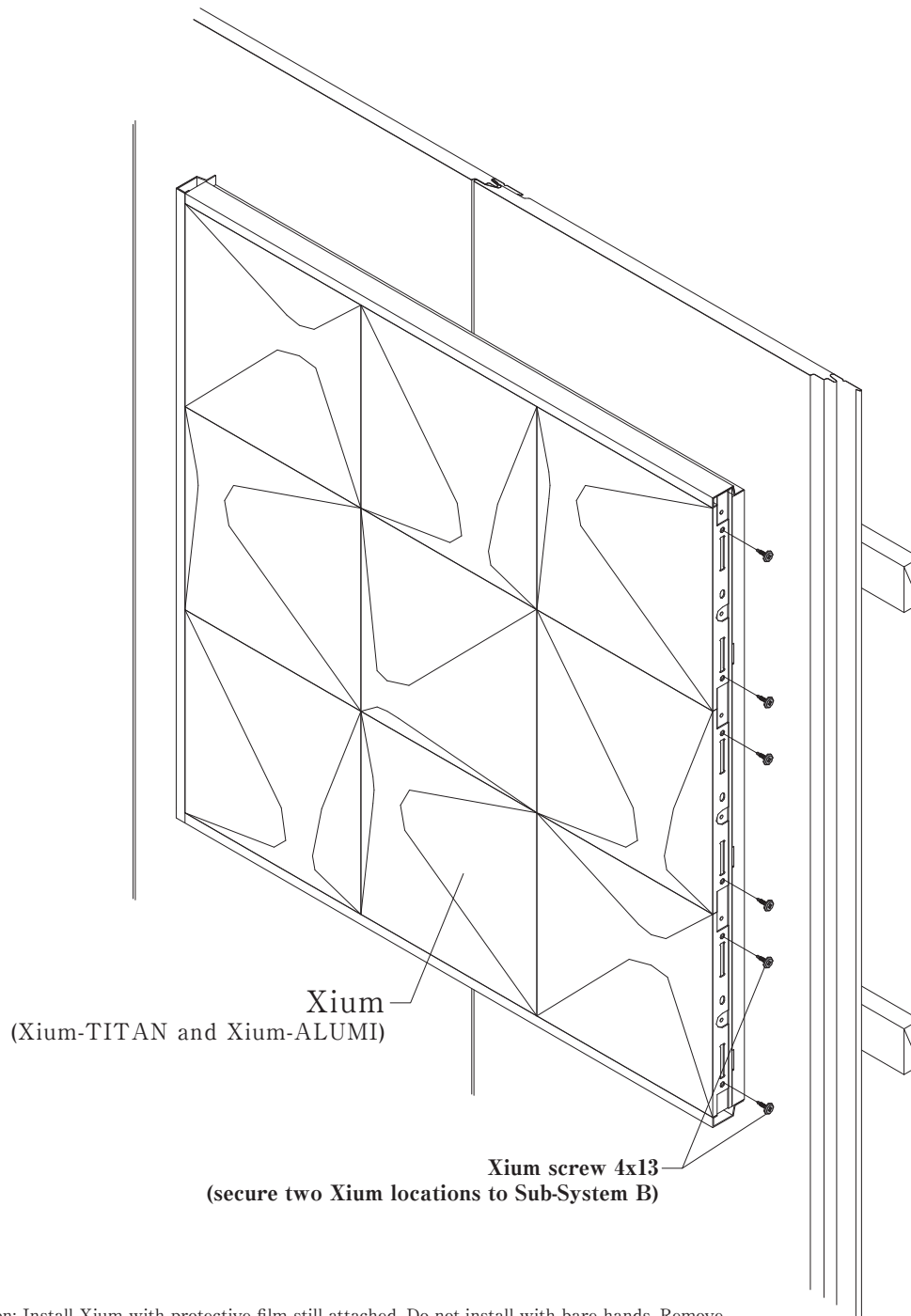

Caution: Install Xium with protective film still attached. Do not install with bare hands. Remove protective film immediately after the completion of Xium installation.

Frame Installation [Right]

- Secure Frame to right Sub-System A with Xium screw 4x13.

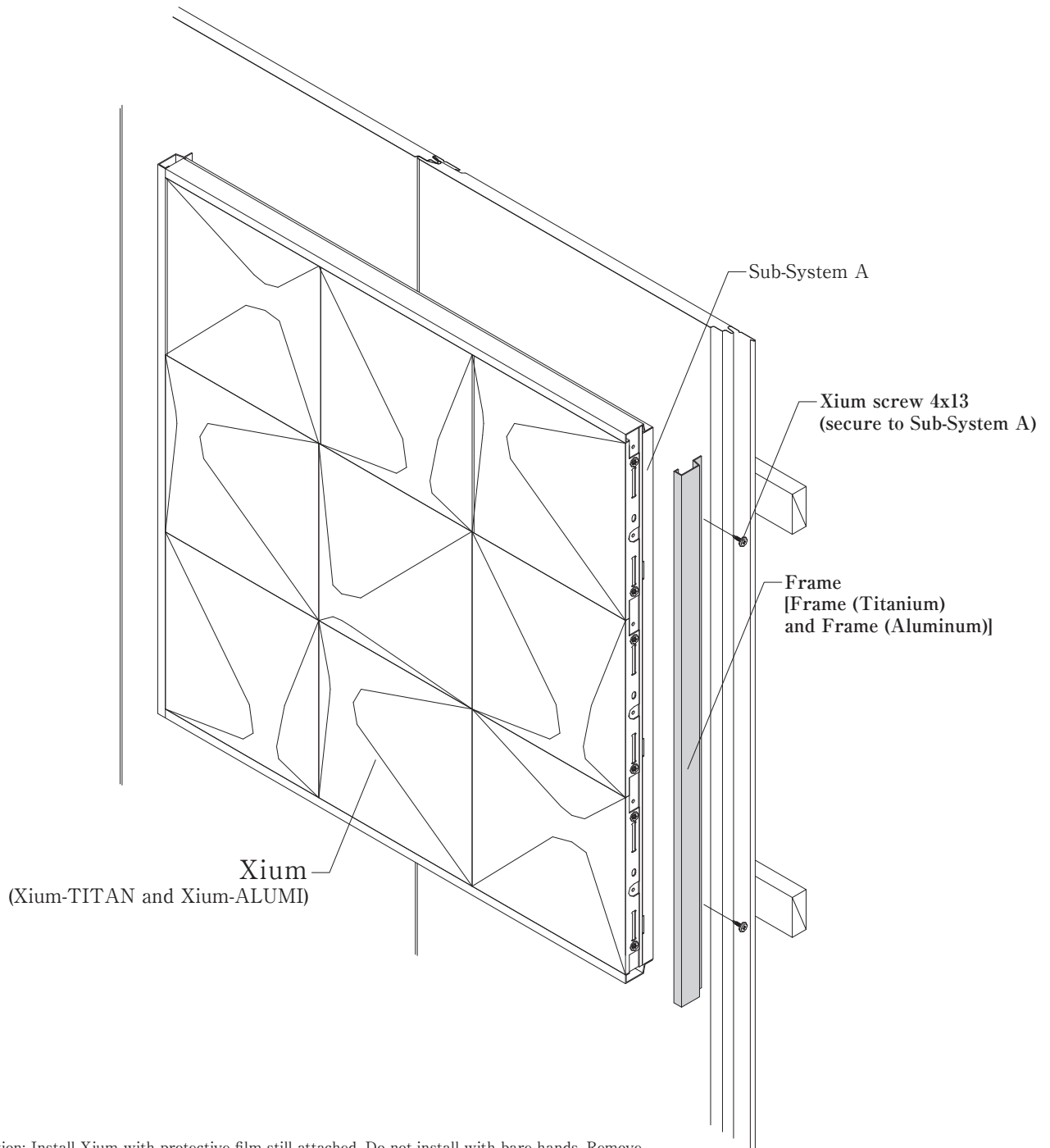

Caution: Install Xium with protective film still attached. Do not install with bare hands. Remove protective film immediately after the completion of Xium installation.

Completion

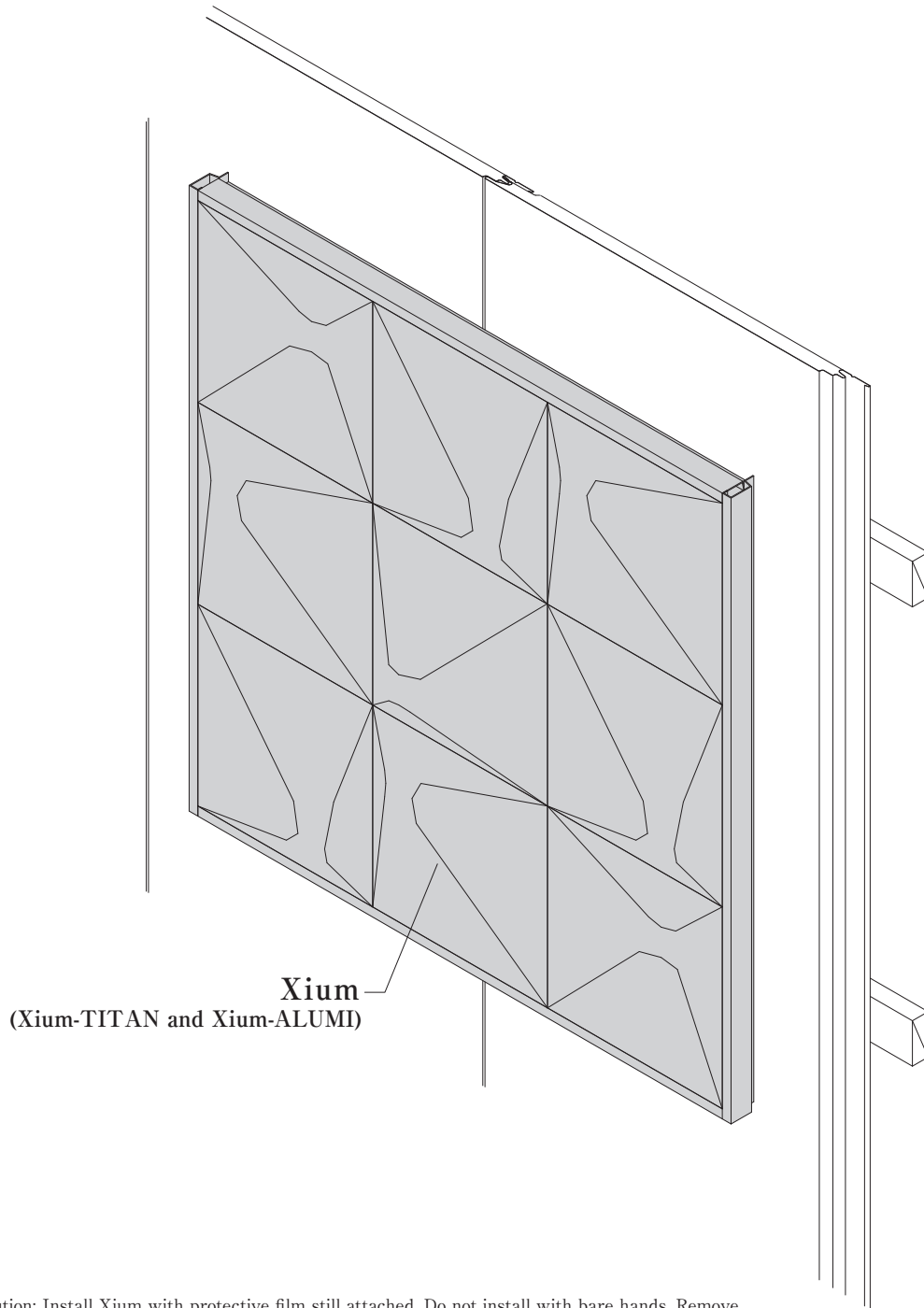

Caution: Install Xium with protective film still attached. Do not install with bare hands. Remove protective film immediately after the completion of Xium installation.

Sectional View

Vertical Cross Section

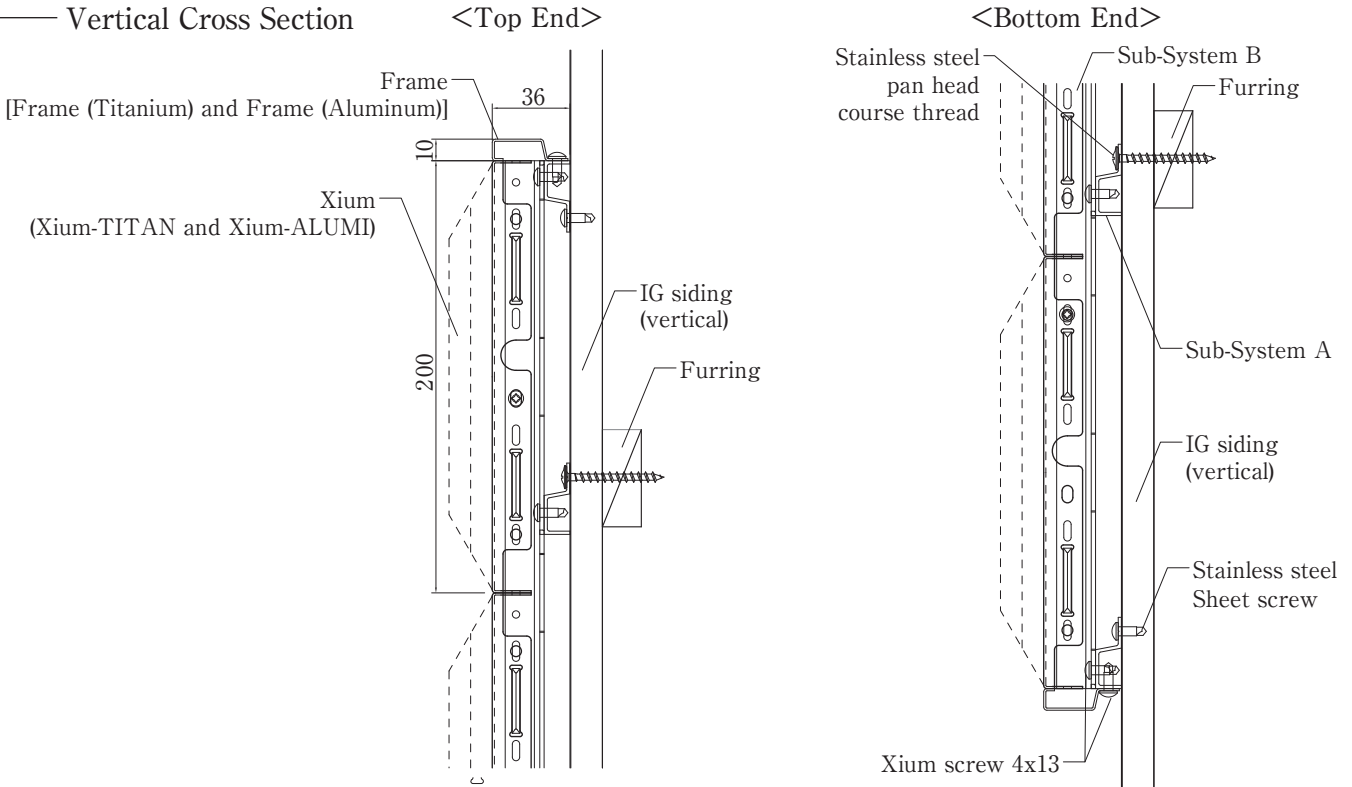

Horizontal Cross Section

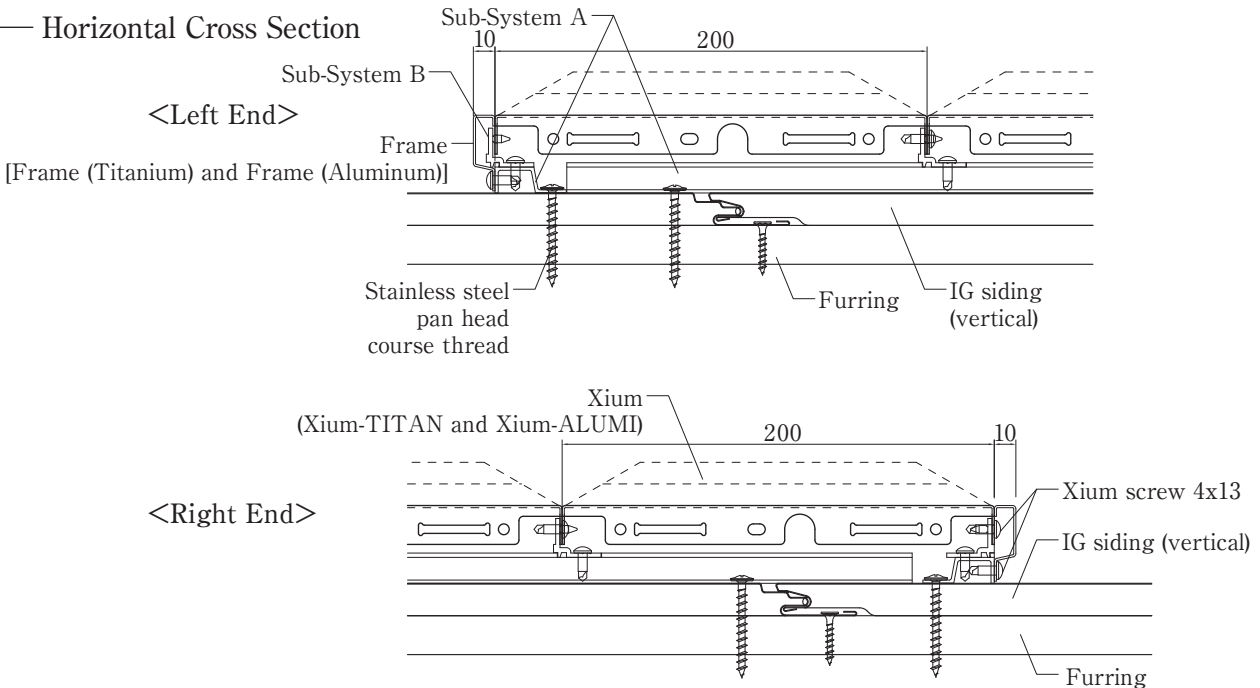

Marking

- Mark the Xium installation perimeter and Sub-System A vertical position.

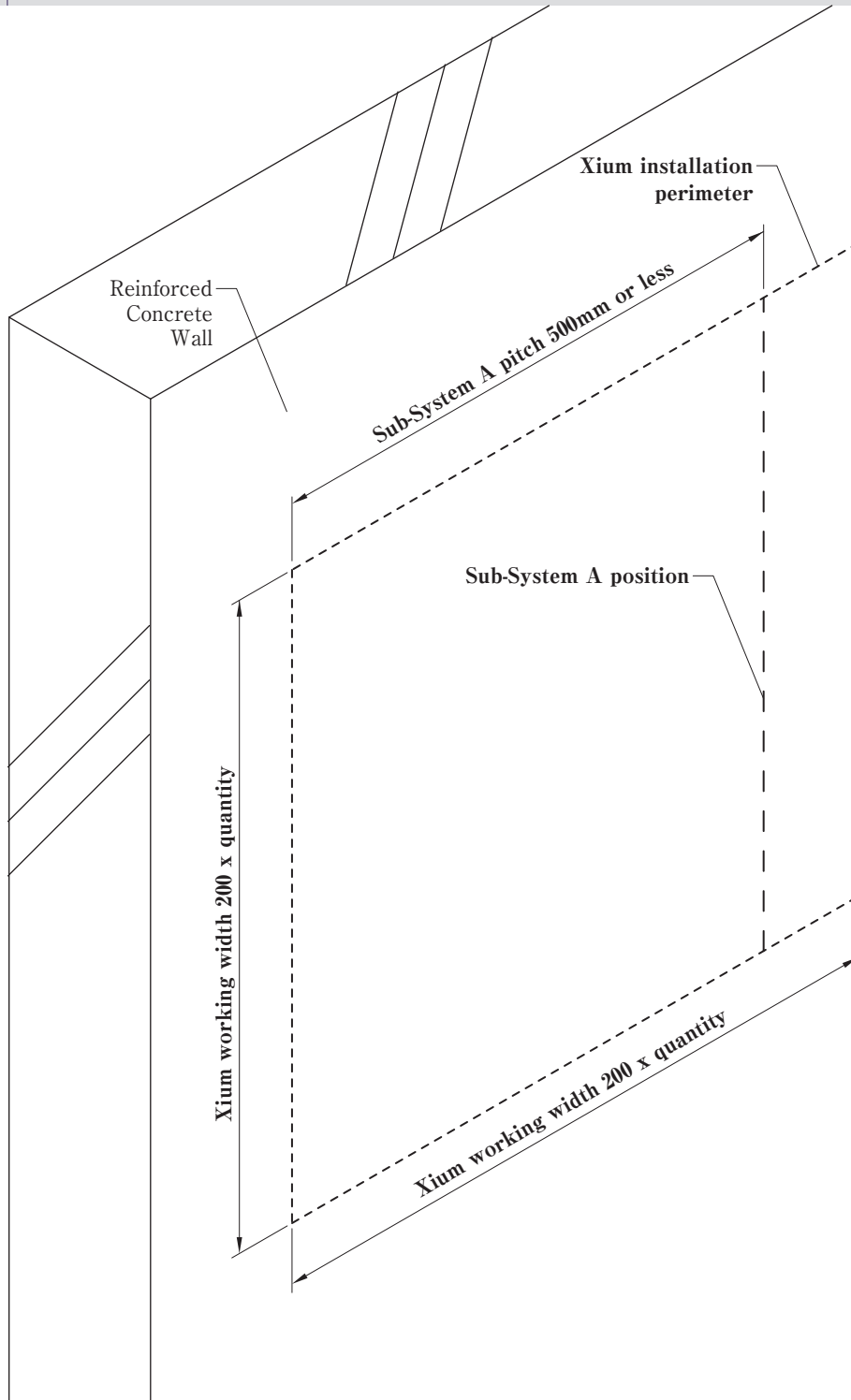

Sub-System A Installation

- Align the sides of Sub-System A with the Xium installation perimeter when installing.
- Install Sub-System A with a pitch of 500mm or less within the Sub-System A perimeter.
- For fastening Sub-System A, use stainless steel reinforced concrete screws with a pitch of 500mm or less. Also install after drilling pilot holes into Sub-System A and Reinforced Concrete wall. For further details, see reinforced concrete screw manufacturer's catalog.

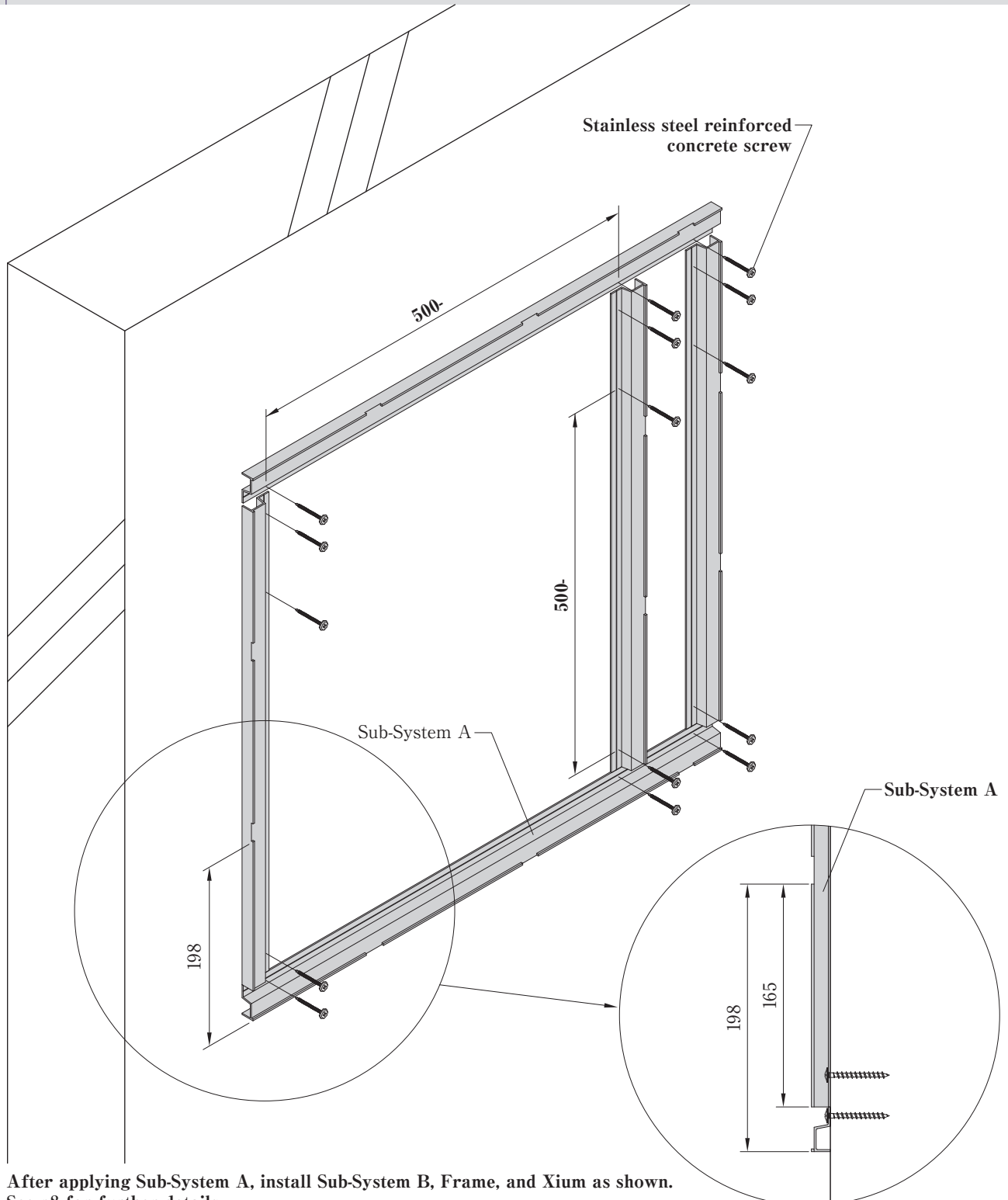

After applying Sub-System A, install Sub-System B, Frame, and Xium as shown. See p8 for further details.

Cutting Layout Example

• This section explains how to cut Sub-System A and Sub-System B under the following conditions.

Condition: Construction for IG siding (horizontal)

Xium 3 x 3 = 9

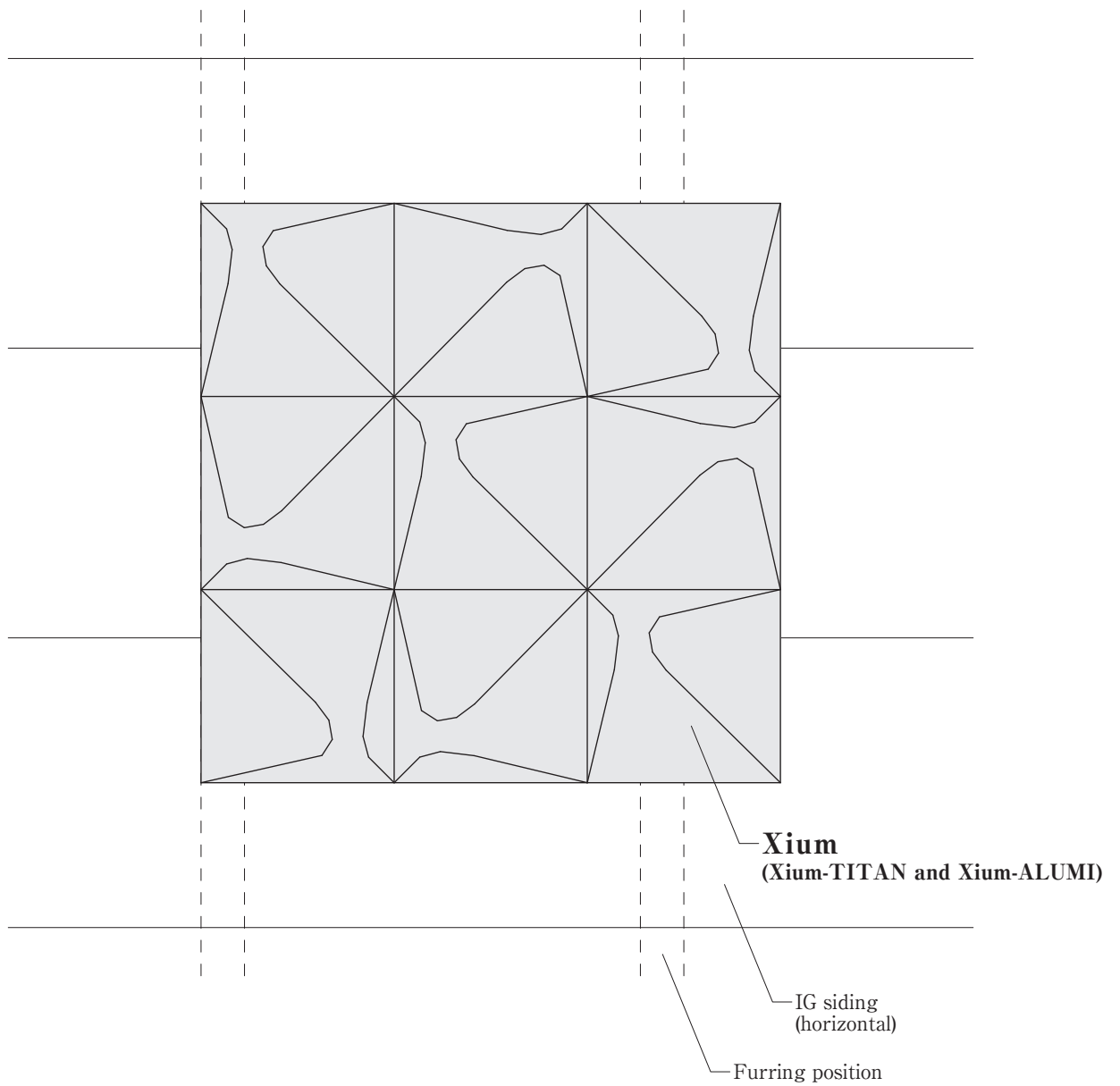

Marking

- Mark the Xium installation perimeter and furring position.

Ex: Construction for IG siding (horizontal)
Xium 3 x 3

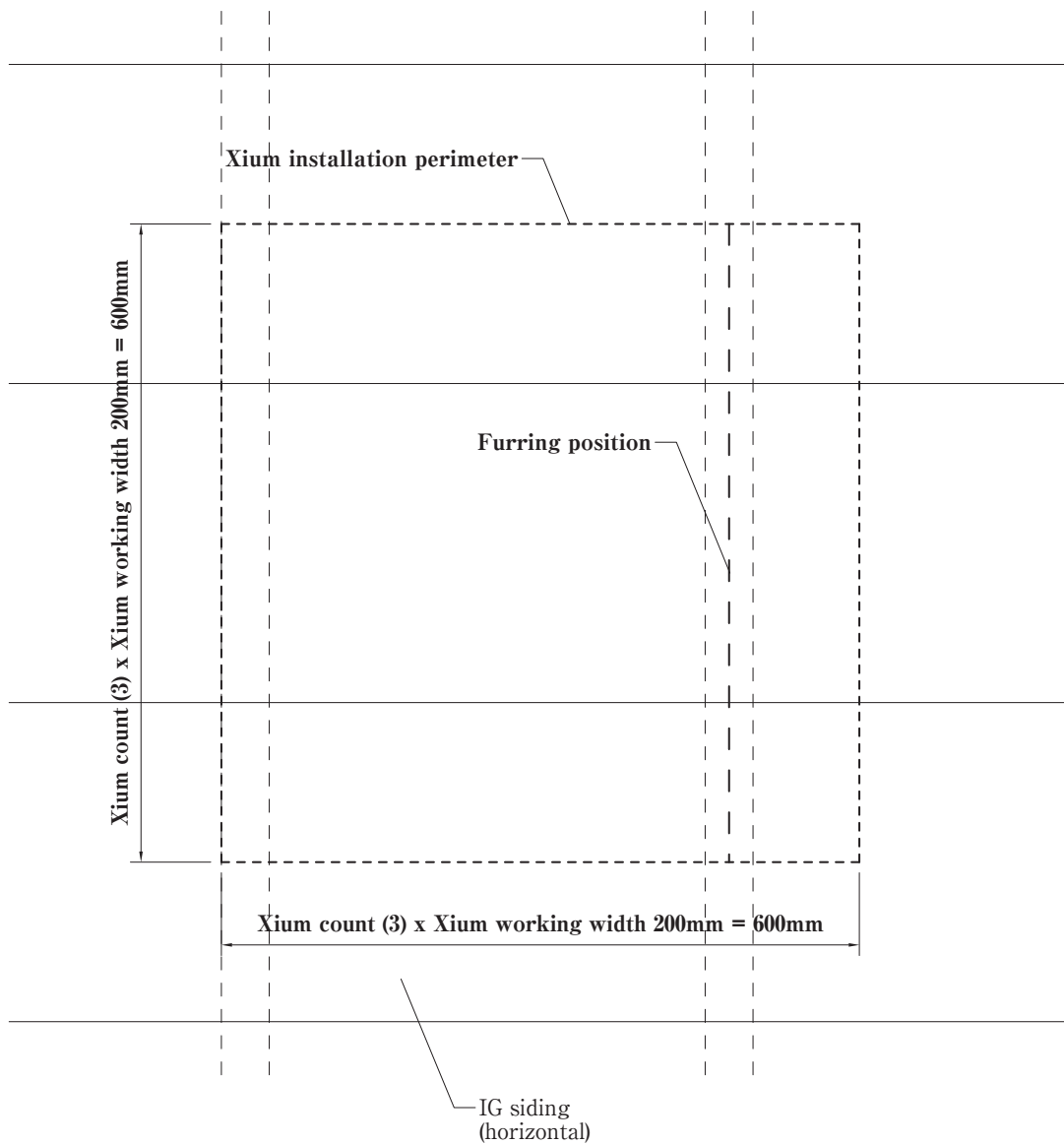

Sub-System A Cutting

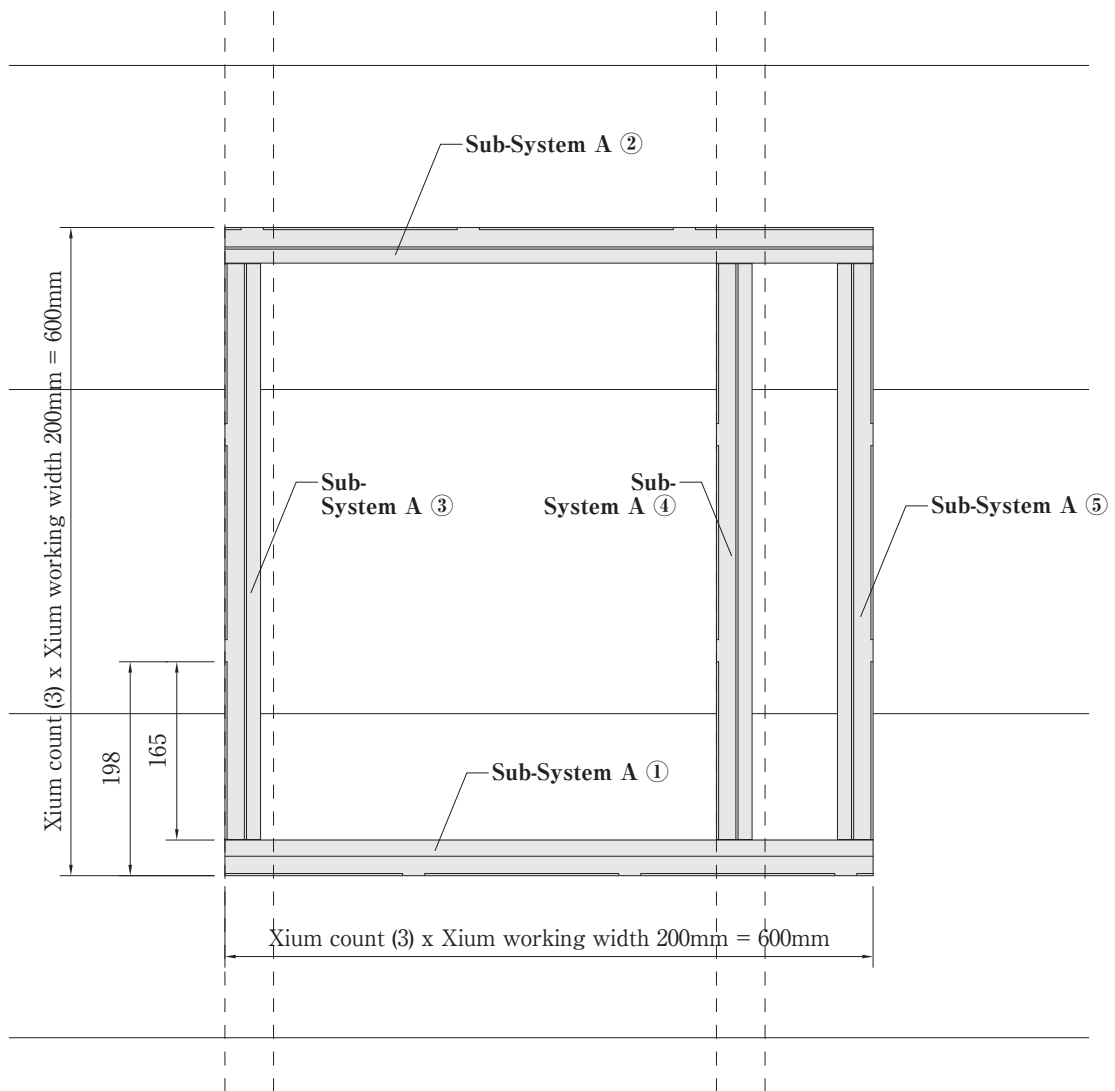

Sub-System A ①② — Cutting Length: Xium count (3) x Xium working width 200mm = 600mm
Notch Position: Any

Sub-System A ③④⑤ — Cutting Length: Xium count (3) x Xium working width 200mm - Sub-System A
Top and bottom total width 66m+ = 534mm or less

Notch Position: Cut lower side to 165mm or less, up to the notch

※ Install following dimensions shown.

Note that the orientation of the left side Sub-System A ③ is different to the right side Sub-System A ⑤.

Sub-System B Cutting

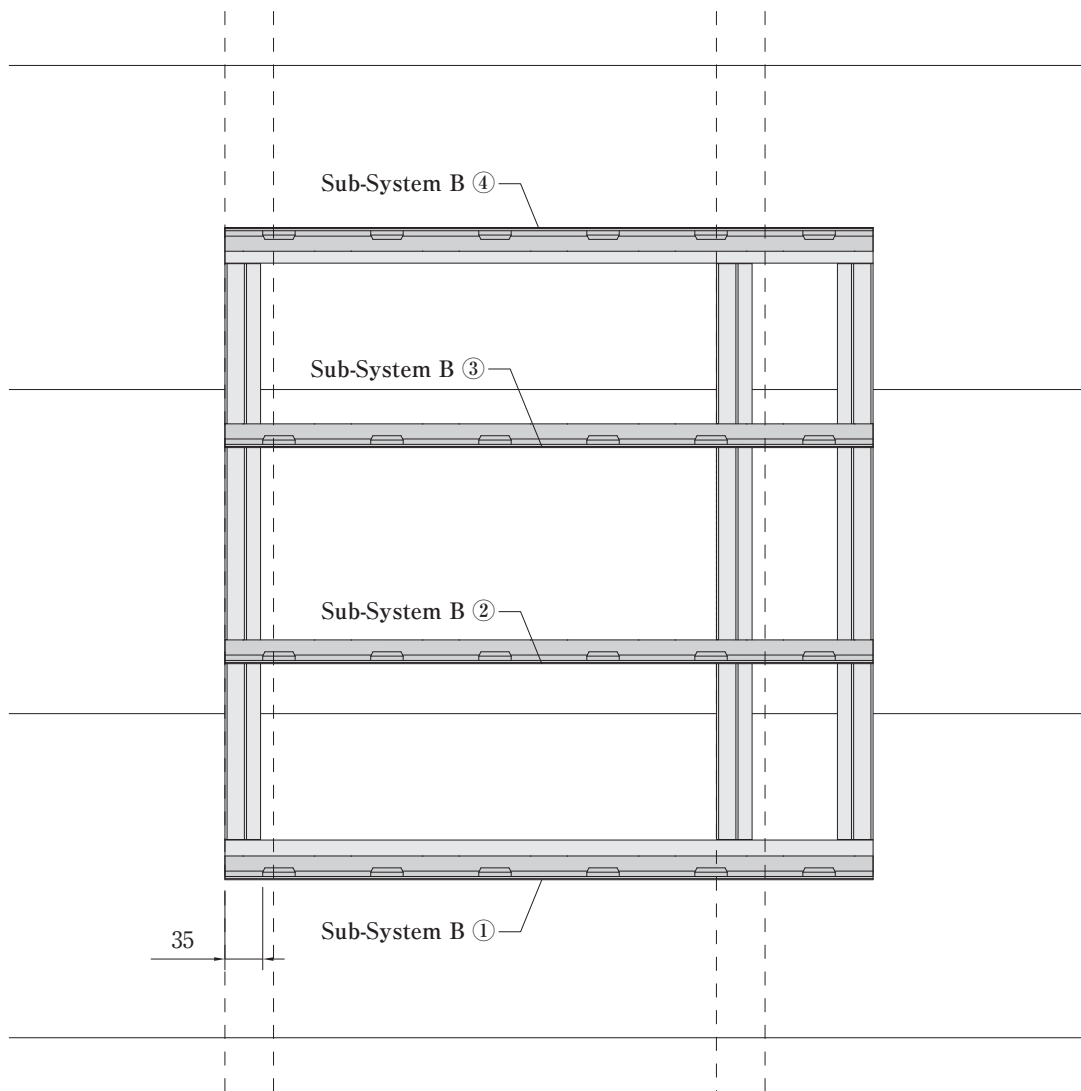

Sub-System B ①②③④ — Cutting Length: Xium count (3) x Xium working width 200mm = 600mm

Notch Position: Cut a distance of 35mm from the left side to the protrusion.

※ Note that only the orientation of the top side Sub-System B ④ is different from other Sub-System B.

1. For Xium-TITAN

■ Maintenance Methods

· Removal of Impurities from Finger / Handprints

In most cases, these impurities can be wiped off with a neutral detergent or soapy water.

If impurities are not removed, wipe the area with a sponge or cloth moistened with an organic solvent (such as alcohol or benzene).

After wiping, it is important to wipe the area off with a clean new cloth before the organic solvent dries.

· Removal of Impurities from Rain, Dust, etc.

In most cases, these impurities can be wiped off with a neutral or alkaline detergent, but if the impurities are not removed this way, apply an abrasive cleanser to a soft cloth, and rub gently and evenly.

Conclude maintenance by washing thoroughly with water so as not to leave behind any chemicals.

■ Maintenance Precautions

· Causes and circumstances of dirt buildup and discoloration vary, so cleaning must be carried out according to each specific situation.

Try test cleaning a small portion and check for dirt and discoloration. If there are no issues, use that method to clean the entire surface.

· When using cleaning tools such as a cloth, sponge, loofah, scrubbing brush, brush, or fine nylon pad, etc., move your hands as evenly as possible.

· If using a commercially available cleaning solution to remove impurities from Xium-TITAN, be sure to clean not only the dirty portion, but the surrounding area as well. Cleaning only a portion of the area may leave behind uneven color and other imperfections.

2. For Xium-ALUMI

■ Maintenance Methods

· Removal of Impurities from Finger / Handprints, Rain, Dust

Clean with a neutral detergent. Wash thoroughly with water so as not to leave behind any detergent residue.

After cleaning, it is important to wipe off with a clean new cloth.

■ Measures Against Rain and Condensation

· For Xium-ALUMI, condensation may occur on the material's surface due to changes in outside temperature and humidity. If left unattended, white flower pattern corrosion may occur. In the event that something like this happens, please check the following points and take corrective action.

① Let it dry naturally, and wipe off with a dry cloth after moisture has evaporated.

② Note that wiping the surface with a hand or cloth while moisture is still present can cause a wide range of stains.



IG KOGYO